

# User manual

## Feeder Ironer Folder & Stacker

IV648xxFFS Vibe

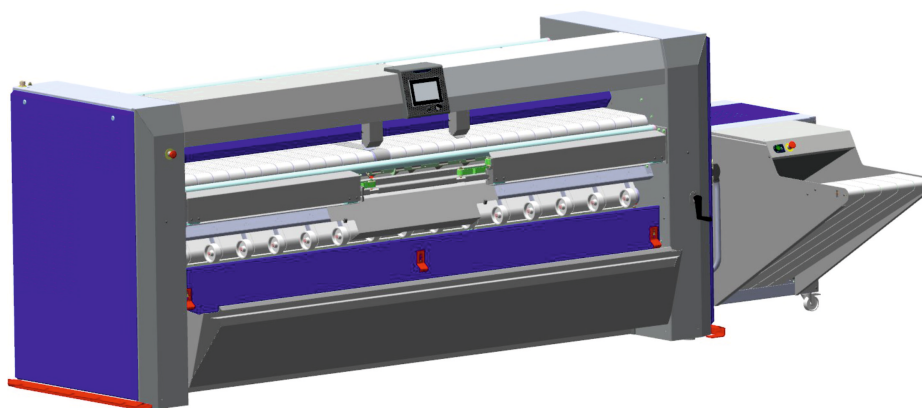

Originals instructions



**Electrolux**  
PROFESSIONAL

01102062/EN



# Contents

---

## Contents

1	Preliminary instructions.....	5
1.1	Precautions for use.....	6
1.2	Symbols.....	7
1.3	Personal protection equipment.....	8
1.4	Emergency stop.....	8
2	Warranty terms and exclusions.....	9
3	Ergonomics certification.....	10
4	Limits and specifications.....	11
5	Note about the A.C. power.....	13
6	Method of use.....	13
6.1	Description of the machine.....	13
6.1.1	General instructions.....	13
6.1.2	Safety devices.....	14
6.2	Feeding table protection device.....	14
6.3	Control handle.....	14
6.4	Stacker control panel.....	15
6.5	Controller description.....	16
6.5.1	Description.....	16
6.5.2	How to operate.....	17
7	Use.....	20
7.1	Power-on daily operation.....	20
7.2	Programs management.....	21
7.2.1	Enter ID operator.....	22
7.2.2	Select program.....	23
7.2.3	Program running.....	24
7.2.4	See service tasks status.....	27
7.2.5	Input PIN code to access higher level.....	28
7.3	Ironing.....	28
7.3.1	Use recommendations.....	29
7.4	Stopping the machine.....	30
8	Advanced use.....	31
8.1	PCB Vibe Settings menus.....	31
8.2	Basic settings.....	32
8.2.1	PCB Vibe — Language setting.....	32
8.2.2	PCB Vibe — Clock setting.....	33
8.2.3	PCB Vibe — Date setting.....	34
8.2.4	PCB Vibe — Units setting.....	36
8.2.5	PCB Vibe — PIN code setting.....	37
8.2.6	PCB Vibe — Customers definition.....	38
8.2.7	PCB Vibe — Operators creation.....	39
8.2.8	PCB Vibe — Contact definition.....	41
8.3	Advanced settings.....	42
8.3.1	PCB Vibe — Machine parameters.....	42
8.3.2	PCB Vibe — Function parameters.....	42
8.3.3	PCB Vibe — Machine timers.....	43
8.3.4	PCB Vibe — Restore factory settings.....	43
8.3.5	PCB Vibe — Default access level.....	44
9	Errors codes.....	45
9.1	Error code 01 — Emergency stop.....	45
9.2	Error code 02 — Gas pressure.....	45
9.3	Error code 03 — Gas ignition.....	45
9.4	Error code 04 — Contactors failure.....	45
9.5	Error code 05 — Overheating.....	46
9.6	Error code 06 — Overheating bis.....	46
9.7	Error code 07 — Transmission.....	46
9.8	Error code 08 — Thermal fuse.....	47
9.9	Error code 09 — Safety thermostat.....	47
9.10	Error code 10 — Safety thermostat bis.....	47
9.11	Error code 11 — Exhaust issue.....	47
9.12	Error code 12 — Feeder protection.....	48
9.13	Error code 100 — Feeder clamp sensor left.....	48

# Contents

---

9.14	Error code 101 — Feeder clamp sensor right .....	48
9.15	Error code 102 — Feeder clamps position switch .....	48
9.16	Error code 103 — Feeder clamp center position .....	49
9.17	Error code 104 — Feeder clamp lateral position .....	49
9.18	Error code 105 — Feeder trailer switches .....	49
9.19	Error code 106 — Feeder trailer front switch .....	50
9.20	Error code 107 — Feeder trailer middle switch .....	50
9.21	Error code 108 — Feeder trailer rear switch .....	50
9.22	Error code 109 — Dewrinkling sensor .....	50
9.23	Error code 200 — LF folding arm .....	51
9.24	Error code 201 — LF clutch .....	51
9.25	Error code 202 — Transfer .....	51
9.26	Error code 300 — Air pressure .....	51
9.27	Error code 301 — Cross 1 jam .....	52
9.28	Error code 302 — Cross 2/3 jam .....	52
9.29	Error code 303 — Cross exit jam .....	52
9.30	Error code 304 — Cross front left sensor .....	52
9.31	Error code 305 — Cross front right sensor .....	53
9.32	Error code 306 — Cross middle right sensor .....	53
9.33	Error code 307 — Cross middle left sensor .....	53
9.34	Error code 308 — Cross rear left sensor .....	53
9.35	Error code 310 — Rear panel sensor .....	54
9.36	Error code 400 — Stacker height sensor .....	54
9.37	Error code 401 — Stacker entry sensor .....	54
9.38	Error code 402 — Stacker flaps sensor .....	54
9.39	Error code 403 — Stacker flaps opening motion .....	55
9.40	Error code 404 — Stacker reset failure .....	55
10	Maintenance .....	56
10.1	Preventive maintenance .....	56
10.2	Using the handle .....	57
11	Technical characteristics .....	57
12	Conversion of measurement units .....	61
13	Explanation of washing symbols .....	62
13.1	Washing .....	62
13.2	Bleaching .....	62
13.3	Drying .....	63
13.4	Ironing .....	63
13.5	Dry or water cleaning .....	63

The manufacturer reserves the right to make changes to design and component specifications.

## 1 Preliminary instructions

Before any use, it is compulsory to read the instruction handbook.

Users must have learnt how the machine operates.

In order to prevent any risk of fire or explosion, flammable products should never be used to clean the machine.

**This machine should be installed in conformance to the health and safety regulations, and only used in a sufficiently aerated area. Check the instructions before installing or using the machine.**



### Caution



**The mechanical and electrical installation of the machine should only be done by qualified personnel.**



**Do not use the machine unless it is plugged into a correctly earthed power socket complying with standards in force.**



### Caution



**This device must not be installed in places accessible to the public.**



### Warning



**Make sure the machine is disconnected from the mains before repairing or servicing.**



### Important



**Any repairing or maintenance operation should be carried out by a specialist.**



### Important



**The machine is delivered with a wall instructions paper to be clearly fixed near the machine.**



### Important



**After the installation, Send back the commissioning form ,signed document, to Electrolux to validate the warranty of the product.**



### Caution



**Disconnect all sources of energy and let the ironing cylinder cool down before any intervention on the machine. The high temperature of the ironing cylinder may cause serious burns ; avoid touching the hot surfaces.**

**Danger**

Never iron if the finger protection does not function.

**Important**

The machines comply with the European Directive EMC (ElectroMagnetic Compatibility). They have been tested in laboratory and approved as such. It is so prohibited to add wires or non shielded electric cables in the cabinets, strands or cables'troughs.

**Important**

**It is specially advised not to install the machine on a synthetic floor covering. The frictional electricity may hinder the good working of the machine**  
**Under no circumstances should a gas-heating machine be installed in a building which includes a dry-cleaning machine.**  
**This is particularly important for your safety and that of others. The consequence is an immediate cancellation of the warranty.**

**Important**

**When using the machine in automatic folding mode, you could catch your fingers when the sheet removal actuator ascends/descends with the anti-static device and in folding arm movements.**  
**Do not operate on the machine without powering down beforehand.**

**Caution**

**For your own safety, it is prohibited and dangerous to solder the ironing cylinder. If a leak occurs, never try to repair it yourself. Ask our technical departments for advice.**







**The machine can work without the protective casing when the electric supply is not cut off.**  
**Interlock the main isolating switch with a padlock.**  
**Close the steam inlet valves.**  
**If you detect gas smells, turn off the gas, open the windows, do not activate any switch and warn the maintenance service.**  
**The warranty might be cancelled if these instructions are not complied with.**

**1.1 Precautions for use**



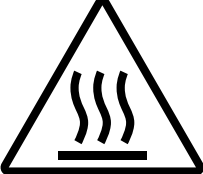
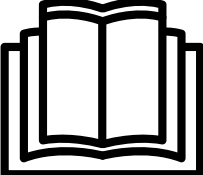



- The machine should not be used by children.
- This ironer must be used exclusively for textiles appropriate for machine ironing, which have been previously and exclusively washed in water.
- This machine is for professional use and must be used exclusively by qualified personnel.
- Blankets should not be ironed.
- Do not iron linen coated with solvent, paint, wax, grease or any easily inflammable products.
- In case of gas heated machine, do not assemble the machine on premises containing a dry cleaning machines or other similar machines.

## 1.2 Symbols

	<p>Caution. An exclamation mark inside an equilateral triangle offers the user important advice about usage, servicing, and hazardous conditions</p>
	<p>Caution, presence of dangerous current. A flash lightning with an arrow at its end inside an equilateral triangle, warns the user about the presence of uninsulated "dangerous current" sufficient in intensity to cause electrocution.</p>
	<p>Caution, hot surface. This symbols warns the user of the presence of high temperatures which could cause severe burns. Some surfaces can reach close to 200°C (392°F).</p>
	<p>Read the instructions before using the machine.</p>
	<p>Warning, do not operate with casing removed. This symbol warns the user that there are mechanisms inside the machine which can be dangerous. The protective housing must be in place during use.</p>

### 1.3 Personal protection equipment

Given below is a summary table of the Personal Protection Equipment (PPE) to be used during the various phases of the machine's service life.

Phase	Protection garments 	Safety footwear 	Gloves 	Glasses 	Ear protectors 	Mask 	Safety helmet 
Transport		X	O				
Handling		X	O				
Unpacking		X	O				
Installation		X	O				
Normal use	X	X	X	X			
Adjustments	O	X					
Routine cleaning	O	X	X	O			
Extraordinary cleaning	O	X	X	O			
Maintenance	O	X	O				
Dismantling	O	X	O				
Scrapping	O	X	O				

**Legend :** X : PPE required ; O : PPE available or to be used if necessary.

**Normal use :** Safety footwear must be defined for a use on a wet floor. And use glasses and gloves to manipulate chemical products.

### 1.4 Emergency stop

The emergency stop must be unblocked, if not the machine will not work (to unblock, turn the red button to the right). If the machine for some reason has to be stopped, abnormal or dangerous running, press the emergency stop button.

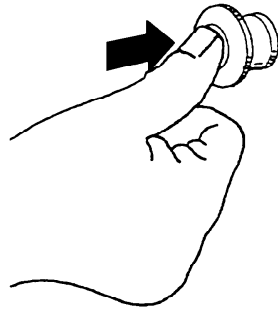

Release the emergency stop, by turning it clockwise only after checking what motivated this stop.

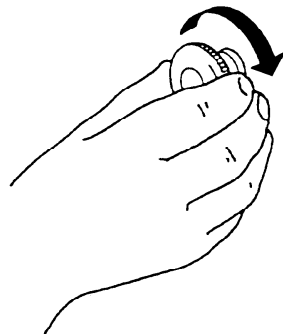



## 2 Warranty terms and exclusions

If the purchase of this product includes warranty coverage, warranty is provided in line with local regulations and subject to the product being installed and used for the purposes as designed, and as described within the appropriate equipment documentation.

Warranty will be applicable where the customer has used only genuine spare parts and has performed maintenance in accordance with Electrolux Professional user and maintenance documentation made available in paper or electronic format.

Electrolux Professional strongly recommends using Electrolux Professional approved cleaning, rinse and descaling agents to obtain optimal results and maintain product efficiency over time.

The Electrolux Professional warranty does not cover:

- service trips cost to deliver and pick up the product;
- installation;
- training on how to use/operate;
- replacement (and/or supply) of wear and tear parts unless resulting from defects in materials or workmanship reported within one (1) week from the failure;
- correction of external wiring;
- correction of unauthorized repairs as well as any damages, failures and inefficiencies caused by and/or resulting from;
  - insufficient and/or abnormal capacity of the electrical systems (current/voltage/frequency, including spikes and/or outages);
  - inadequate or interrupted water supply, steam, air, gas (including impurities and/or other that does not comply with the technical requirements for each appliance);
  - plumbing parts, components or consumable cleaning products that are not approved by the manufacturer;
  - customer's negligence, misuse, abuse and/or non-compliance with the use and care instructions detailed within the appropriate equipment documentation;
  - improper or poor: installation, repair, maintenance (including tampering, modifications and repairs carried out by third parties not authorized third parties) and modification of safety systems;
  - Use of non-original components (e.g.: consumables, wear and tear, or spare parts);
  - environment conditions provoking thermal (e.g. overheating/freezing) or chemical (e.g. corrosion/oxidation) stress;
  - foreign objects placed in- or connected to- the product;
  - accidents or force majeure;
  - transportation and handling, including scratches, dents, chips, and/or other damage to the finish of the product, unless such damage results from defects in materials or workmanship and is reported within one (1) week of delivery unless otherwise agreed;
- product with original serial numbers that have been removed, altered or cannot be readily determined;
- replacement of light bulbs, filters or any consumable parts;
- any accessories and software not approved or specified by Electrolux Professional.

Warranty does not include scheduled maintenance activities (including the parts required for it) or the supply of cleaning agents unless specifically covered within any local agreement, subject to local terms and conditions.

Check on Electrolux Professional website the list of authorized customer care.

### 3 Ergonomics certification

The human body is designed for movement and activity but physical stress injuries as a result of static and repetitive movements or unfavorable working postures may occur.

The ergonomic features of our product, the ones which may influence your physical and cognitive interaction with it, have been assessed and certified.

A product which exhibits ergonomic features, in fact, shall fulfil specific ergonomic requirements, belonging to three different areas: Polytechnic, Biomedical and Psychosocial (usability and satisfaction).

For each of these areas, specific tests with real users have been performed. The product was therefore compliant with the ergonomic acceptability criteria requested by the standards applied.

The product that you use is specifically studied and tested in order to minimise any physical problems associated to the interactions with the product.

We would like to point out some operating procedures we suggest to adopt:

- Handle the linen in a balanced way, trying not to arch your back during the loading/unloading.
- Take in/out the laundry in small quantities.
- In order to avoid the entanglement of laundry including large dishes, add more rotation time in each direction.

- If possible, flex your legs and don't bend forward your back during the placement of the linen in the lower box and during the achievement of any lower maintenance actions or items.

- If possible, push the tray cart and pull it in order to reduce the distances.

- Keep the viewing distance in order to understand properly the information displayed in the interface or to view you interest in the ironer, reducing as much as possible the time spent with the eyes up (neck extensions).

In case several machines are managed by the same operator the repetitive movements will increase and as a consequence of this the related biomechanical risk will increase exponentially.

Follow the below recommendations to avoid, as much as possible, operators acquiring bodily injury.

- Make sure there are suitable trolleys or baskets for loading, unloading and transportation.
- We advise you to use a mobile bottom trolley with a maximum height of 850mm.
- Organize job rotation in the working place in the case several machines are managed by the same operator.

## 4 Limits and specifications



### Important



We draw your attention on the following practices depending on your machine.. They will have consequences on the quality of your finished items and can, in some cases, void the warranty of your ironer.

Recommendations and warnings regarding	Description (why and what are the consequences)	Ba-sic	LF	FLF	R	R-LF	FR-LF	FF-S
<b>Multi layer items</b>	Sheets folded in two layers or more will be much longer to dry. A double layer sheet will be longer to dry than twice the time of a single layer. The several layers of a sheet may slide against one another depending on their material and quality. The consequences can be a poor ironing quality (wrinkles), will be a poor quality length folding and most probably an impossible cross-folding.	<input checked="" type="checkbox"/>	<input checked="" type="checkbox"/>	<input checked="" type="checkbox"/>	<input checked="" type="checkbox"/>	<input checked="" type="checkbox"/>	<input checked="" type="checkbox"/>	<input checked="" type="checkbox"/>
<b>Worn polycotton sheets (cotton washed away)</b>	Polyester-cotton blended sheets have got a limited lifetime that needs to be considered. Old sheets will have no cotton left after a certain amount of washes. The consequences of ironing them on an ironer are : Increased electro-static unbearable by the machine even if this one is equipped with an anti-static bar. Sheets will stick to parts of the machine creating jams and disrupting the length folding. Photocells may not detect the presence of the sheets, also disrupting the length folding.	<input checked="" type="checkbox"/>	<input checked="" type="checkbox"/>	<input checked="" type="checkbox"/>	<input checked="" type="checkbox"/>	<input checked="" type="checkbox"/>	<input checked="" type="checkbox"/>	<input checked="" type="checkbox"/>
<b>Large items</b>	Your machine cannot automatically feed items wider than its width. For an IC64819 the maximum width is : 1890 mm (74 in) For an IC64821 the maximum width is : 2100 mm (82 in) For an IC64825 the maximum width is : 2520 mm (99 in) For an IC64828 the maximum width is : 2730 mm (107 in) For an IC64832 the maximum width is : 3150 mm (124 in) Your machine cannot fold items longer than <b>3.0 metres (118 in)</b>		<input checked="" type="checkbox"/>	<input checked="" type="checkbox"/>		<input checked="" type="checkbox"/>	<input checked="" type="checkbox"/>	<input checked="" type="checkbox"/>
<b>Size of items in general</b>	Your ironer will deliver optimum results when processing items which width is closest to the maximum acceptable width. Processing smaller items will alter the performance of your ironer. In such cases, it is preferable to operate your ironer in manual mode. example of sheets of 1.80 x 2.80 m (7in x 110in) processed on an IC64825FLF or FFS Gas or Electric heated: they will have to be fed by the 1.80m width (2.80m, 14 9/16in being wider than the machine can feed). The automatic feeding will feed in the middle of the machine leaving 37 cm on either side of each sheet. This practice will quickly lead to an overheating of the sides of the cylinder and dramatically reduce the production of the ironer. You may delay the overheating of sides of the cylinder by alternating the side through which you feed the items. You should always seek to use the maximum width of your ironer.	<input checked="" type="checkbox"/>	<input checked="" type="checkbox"/>	<input checked="" type="checkbox"/>	<input checked="" type="checkbox"/>	<input checked="" type="checkbox"/>	<input checked="" type="checkbox"/>	<input checked="" type="checkbox"/>
<b>Size of items for automatic length folding</b>	The minimum size for items to be automatically Length Folded is 90 cm. Smaller sizes will be systematically dropped or rejected if ironed in folding mode. Note that it is highly recommended not to automatically feed items that are much smaller than the width of the ironer. See "Size of items in general"		<input checked="" type="checkbox"/>	<input checked="" type="checkbox"/>		<input checked="" type="checkbox"/>	<input checked="" type="checkbox"/>	<input checked="" type="checkbox"/>
<b>Size of items for automatic cross folding</b>	The minimum size for items to be automatically cross Folded is 110 cm. Smaller sizes will be systematically rejected to the rear of the FFS ironer.							<input checked="" type="checkbox"/>
<b>Thick items</b>	Thick fabrics may lead to very thick folded items depending on your choice of folding pattern. The maximum thickness acceptable by the cross folding unit is <b>40 mm (1 9/16 in)</b> for the second cross fold and <b>80 mm (3 2/16 in)</b> for the third cross fold. You can modify this thickness by modulating the length folding pattern and/or cancelling the third cross fold (on IC64825 FFS or IC6 4832 FFS). Please refer to the programming manual.							<input checked="" type="checkbox"/>

Recommendations and warnings regarding	Description (why and what are the consequences)	Basic	LF	FLF	R	R-LF	FR-LF	FF-S
<b>Thin items:</b>	Thin and light fabrics (below 80 gr/cm <sup>2</sup> or 0.3 oz/ft <sup>2</sup> ) may cause disruption during the ironing process, particularly in the length folding and not allow optimum quality of folding. They may also jam. You can iron them with precaution.	☑	☑	☑	☑	☑	☑	☑
<b>Particular items:</b>	Your ironer is designed to process flatwork only, such as sheets, duvet covers, pillow cases, table cloths and napkins. Any other items may cause malfunctions of your ironer and may void your warranty. If you are unsure, refer to your nearest Electrolux Professional distributor for advise. Your ironer is not designed for processing the following items : <b>Padded covers</b> : they are too thick and of inappropriate material. <b>Terrycloth</b> : It must be tumble dried. Ironing them will make them very rough. <b>Fitted sheets</b> : elastics may deteriorate following exposure to excessive heat and possibly melt. Depending on their shape and material, they may be ironed if fed into the ironer with elastics facing upward so that they are not in direct contact with the cylinder. In no case they must be automatically fed as the elastics will greatly disrupt the feedin. They cannot be automatically folded for the same reason. <b>Garments</b> : They are of complex shape (not flat) and must be ironed with appropriate finishing equipment. <b>Aprons</b> : They are often flat but feature cords and strings that will jam into moving parts of your ironer. <b>Shower curtains</b> : Their material will not sustain the heat and they will melt on the cylinder.	☑	☑	☑	☑	☑	☑	☑
<b>Inappropriate materials:</b>	Your ironer is designed to safely process cotton, polyester-cotton and flax. For any other material, please refer to your linen supplier and your nearest Electrolux Professional distributor.	☑	☑	☑	☑	☑	☑	☑
<b>Ironer maintenance</b>	Your ironer is designed to run 8 hours without interruption. Every 8 hours and at other set intervals there are a number of required maintenance operations to be performed by yourself or your service engineer. It is critical that you strictly follow these requirements for your ironer to run properly. Please refer to chapter "Preventive Maintenance" of this manual. Should you run your ironer for more than one shift, you must ensure that these maintenance operations are performed between shifts. In addition to these maintenance operations, your ironer should be stopped, cooled and shut down for at least one hour every 24 hours.	☑	☑	☑	☑	☑	☑	☑
<b>Reject ratio</b>	Because flatwork is only flat and rectangle the day you buy it and then rapidly changes shape and characteristics after each wash, it is normal that 4% to 5% are rejected by the machine. Note that the quality of feeding will influence the quality of folding. Items may be rejected because they have not been fed properly. Static electricity and dirty photocells will also interfere with the performance of your ironer. Refer to "Preventive Maintenance" chapter of this manual.		☑	☑		☑	☑	☑
<b>Plivit Length Folding</b>	Your ironer performs a Plivit Length Folding pattern. It is different from an edge to edge folding and from an accordion folding. In order to obtain consistent sizes of folded items, sorting flatwork per size before ironing is paramount. One benefit of Plivit Length Folding is that it allows you to choose the size of the fold in the range of 25 to 43cm (10 to 17in)		☑	☑		☑	☑	☑
<b>Buttons on Duvet covers</b>	Some duvet covers feature various types of fasteners that can be buttons, Velcro, in plastic, metal or wood etc... These duvet covers may be ironed making sure that fasteners are facing up on the feeding table. The drying in the area of the fasteners will be longer than the rest of the duvet cover. This is normal due to the multi-layer of textile in this area and its complex shape. Lying these layers flat on the feeding table will help with a more homogeneous drying. Note that if the thickness of the duvet cover plus the buttons/ fasteners is greater than <b>8mm (5/16 in)</b> , it may interfere with the finger guard protection of your ironer and stop it. This finger guard is a safety device to protect operators getting their fingers caught and driven into the ironer. These elements may disrupt <b>ironing and folding</b> .	☑	☑	☑	☑	☑	☑	☑

## 5 Note about the A.C. power

According to the EN 60204-1:1997 standard, the machine is provided for A.C. supplies corresponding to the extracted characteristics below :

### 4.3.2 A.C. supplies

#### **Voltage:**

Steady state voltage: from 0.9 to 1.1 of nominal voltage.

#### **Frequency:**

from 0.99 to 1.01 of nominal frequency continuously.

from 0.98 to 1.02 short time.

#### **Harmonics:**

Harmonic distortion not to exceed 10 % of the total r.m.s. voltage between live conductors for the sum of the second through to the fifth harmonic. An additional 2 % of the total r.m.s. voltage between live conductors for the sum of the sixth through to the 30th harmonic is permissible.

#### **Voltage unbalance:**

Neither the voltage of the negative sequence component nor the voltage of the zero sequence component in three-phase supplies shall exceed 2 % of the positive sequence component.

#### **Voltage interruption:**

Supply interrupted or at zero voltage for not more than 3 ms at any random time in the supply cycle. There shall be more than 1 second between successive interruptions.

#### **Voltage dips:**

Voltage dips shall not exceed 20 % of the peak voltage of the supply for more than one cycle. There shall be more than 1 second between successive dips.

## 6 Method of use

### 6.1 Description of the machine

#### 6.1.1 General instructions

The machines described in this handbook have a ironing capacity of 210, 250, 320 cm wide depending of the type. They are available with steam, electric or gas heating.

They carry out five different functions with a single operator ; the space required is very similar to the standard ironer's.

The ironing speed is adjustable as a function of the density (weight/m<sup>2</sup>) and humidity of the washing.

The temperature of the ironing cylinder can also be adjusted by a thermostat (except for steam ; in this case, the temperature depends on the steam pressure).

The ironing parameters that you have selected are permanently checked by a microprocessor.

These parameters are displayed in real time on a tactile screen in front of the operator.

The feeding of the linen is completely automatized and includes smoothing ; a single operator is required; the folding of the items is calculated for each item fed.

Several piles of linen can be stored in the stacker with centring and numbering of the folded items.

The machine can be used like a standard ironer with or without the automatic feeding.

This dryer ironer is controlled by a microprocessor- based program control unit placed on the loading side. There are many advantages to this equipment, including :

- Folding adjustment is controlled with great precision and flexibility.
- The large display screen means that detailed information on iron programs, machine status and operations, dry speeds and temperatures can be accessed in plain language.
- It is possible for the user to create new iron programs, and to adapt programs with great precision, on the basis of experience and to suit various types of textile, degrees of moisture and so on...
- A very high level of machine safety through continuous monitoring and built-in safety interlocks.
- Great flexibility during program operation :
  - easy change from DIAMMS mode to till MANUAL mode and inversely.
  - The user can change temperatures and speeds directly, during program operation.
  - change to running a different iron program, at any time during program operation of the dryer ironer.

## 6.1.2 Safety devices

### Accessibility:

All the casings can be dismantled by means of a specially designed tool.

### Emergency stop

An “emergency stop” button is provided on the left side and on the stacker.

### Restarting the machine

After any storage of the machine, either due to power failure, emergency stop, action on the feed safety device, the machine can only be restarted after having pressed “Valid” key.

### Feed safety device = Feeding table protection

The space between the feed safety flap and the drive bands is too small for you to enter your fingers. The machine stops automatically as soon as the flap is pushed in. (see error code 012)

### Power supply failure

If there is a mains power supply failure, use the handle to remove any washing engaged in the machine. If the temperature is too high, use the handle to feed some wet washing and protect the ironing bands.

### Protection of motors

The motors have overload protection :  
by thermomagnetic circuit breakers and  
by the electrical selector (for movement).

### Heating safety device

The control panel applies an initial safety level at the time the machine starts up.

If the temperature is not reached after a given time, the heating command is deactivated.

The operation of the heating function is linked to the rotation of the cylinder. If the cylinder should stop rotating for any reason, the machine stops heating.

A safety thermostat, which is independent of all electronic systems, limits the heating temperature of the ironing cylinder in all circumstances, except in the case of a steam heating machine.

There is a thermal fuse for the overheating safety, in the centre of the machines equipped with a Dubixium cylinder. If it breaks, the heating stops. Contact your dealer to check the origin of the failure by a qualified technician.

### Gas heating

The gas burner is ignited and the flame is controlled by an electronic box that provides integral safety, for example if the flue draft is poor or if the gas supply is cut off.

A message on the tactile screen shows that the system has been put in a safe condition.

A pressure switch connected to the combustion products outlet turns off the machine’s heating function in case of extraction problems.

## 6.2 Feeding table protection device

Check that the feeding table protection device is operating prior to each use.

When this device is activated, the ironing machine stops, the cylinder stops turning and the tray moves back (see error code 012)

## 6.3 Control handle

The control handle will operate differently depending on the parameters selected on the display screen settings.

- In automatic mode, only function (1) is available. Pull the control handle forwards to release the sheet from the clamps and cancel automatic feeding (the sheet will fall into the reception tray).
- If you modify the parameters of the “**basic settings**” menu, the control handle will switch to a semi-automatic or manual mode.

### Start auto feeding = 0

Push the handle to position (2) to start feeding

### Start auto feeding = 1

Feeding will occur automatically after introducing the piece of linen to be dried into the clamps.

### Auto feeding return = 0

Pull the handle to position (1) to bring the feeding clamps back to their initial position.

### Auto feeding return = 1

Feeding return is automatic once the piece of linen has been placed on the feeding belts.

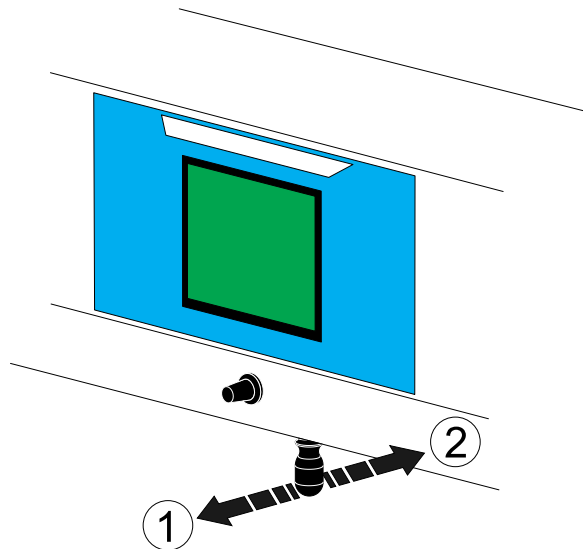

#### 6.4 Stacker control panel

1. Red Emergency stop pushbutton.
2. Green Linen removal pushbutton or re-initialisation of stacker defect.



Note : The dryer-ironer will not operate if the stacker is not connected to the power supply.



When a stack has been created (approx. height : 210 mm) on the stacker deck, this stack will be removed to the evacuation table.

A pushbutton (2) can be used to evacuate the stack of linen manually.

## 6.5 Controller description

### 6.5.1 Description

Control system is made by:

- 1 • Touched screen controller (PLC)  
The controller memory has the firmware that allows the machine to run.

The touched screen is fixed with some locker pin

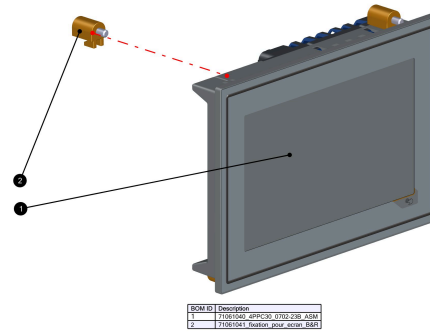

Ref	Description
1	71061002_20VDC_24VDC_0701209_A8M
2	71061041 fixation pour écran B8M

- 2 In addition to the Touched screen controller some inputs / outputs modules are located in the electrical cabinet.  
Inputs / outputs modules are implemented according machine options.

- 3 Each module has :
  - A support.
  - An electronic module.
  - A connector module

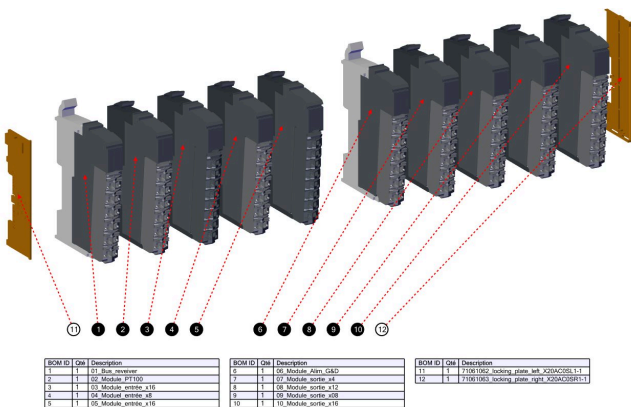

BOM ID	Qty	Description
11	1	02_Bus_reverser
12	1	02_Module_21700
13	1	03_Module_20000_416
14	1	03_Module_20000_418
15	1	05_Module_20000_419
16	1	05_Module_20000_419
17	1	05_Module_20000_419
18	1	05_Module_20000_419
19	1	05_Module_20000_419
20	1	10_Module_serie_419

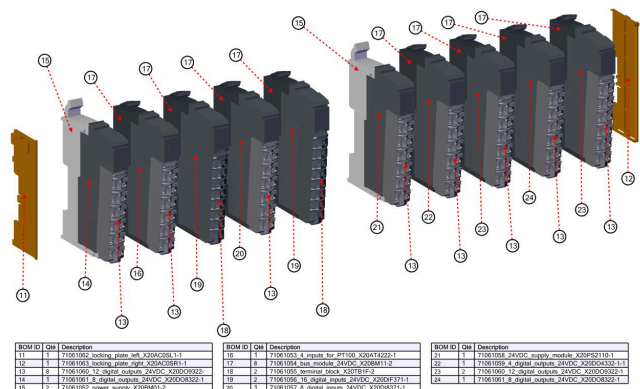

BOM ID	Qty	Description
11	1	71061002_locking_gate_24VDC_0204026_L1
12	1	71061003_locking_gate_24VDC_0204026_L1
13	1	71061004_locking_gate_24VDC_0204026_L1
14	1	71061005_locking_gate_24VDC_0204026_L1
15	2	71061002_power_supply_20000_419
16	1	71061003_4 outputs for 21700_20000_419
17	1	71061004_4 outputs for 21700_20000_419
18	2	71061005_24VDC_24VDC_20000_419
19	2	71061006_24VDC_24VDC_20000_419
20	1	71061007_8 digital outputs_24VDC_20000_419
21	1	71061008_24VDC_supply_module_20000_419
22	1	71061009_4 digital outputs_24VDC_20000_419
23	2	71061005_24VDC_24VDC_20000_419
24	1	71061001_8 digital outputs_24VDC_20000_419



## 6.5.2 How to operate

As describe in previous chapter the Controller is a touch screen interface. To interact with the controller action on touched screen are needed.

### 6.5.2.1 Most common shortcut icons

In this chapter, you will find the explanation of the most common icons use on the controller system.

**1** Navigation & short cut button of the controller display.



- Go back (of 1 step) to previous menu.



- Move to previous line or page.



- Move to next line or page.



- Green highlight cell or line = Active selection.

**2** Navigation & short cut button of the controller display..



- Go in edition mode of the selected cell or line. Will open a new windows



- Open a scroll menu to chose new value or setting. Current value will be highlighted in green. Select new choice by pressing on touch screen.. Scroll menu will close itself after selection. To go back without change select highlighted value.



- In text edit mode, deletes the last entry.

**3** "Hamburger" menu:  
 • Allows to open a sub-menu to go on additional options or functions



**4**

On top of the screen, the “hamburger” menu is closed.

- Press on the 3 horizontal bars to open the “hamburger” menu.

**5**

- The “hamburger” menu will scroll down
- A new windows appears given access to additional options or functions.

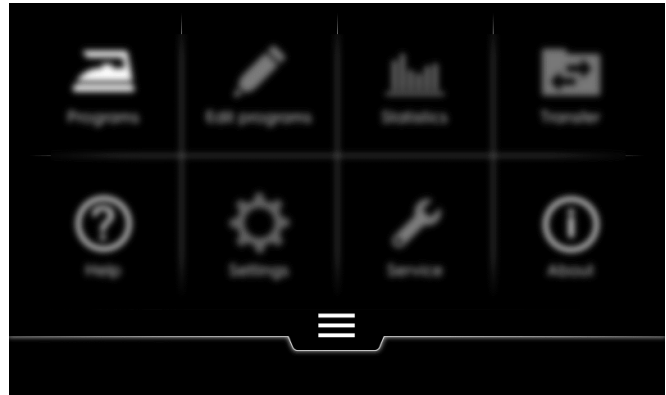
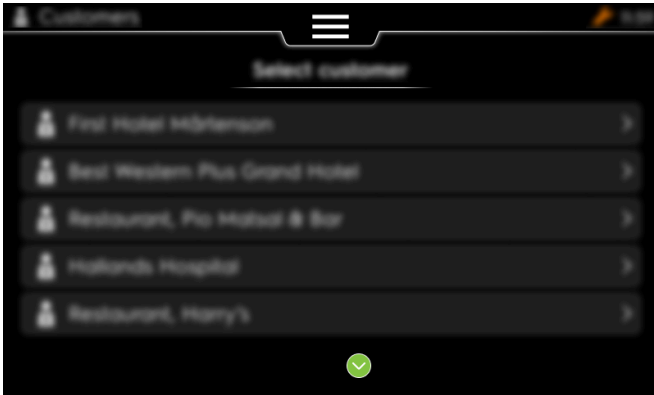

6.5.2.2 Main Menu

**1** Grey icons are deactivated.

**2** There are 4 ID levels  
 1. Level 0 = Operator ID  
 2. Level 1 = Owner / Laundry manager / Team leader.  
 3. Level 2 = Technician Electroluxprofessional.

For all users  
 Back to the program list where the user/operator selects and then starts a program with all the parameters(temp., speed, folding, feeding,...) defined.

For advanced users  
 To the program list where the user can duplicate programs and then change name, icon and change all the parameters in the new program.

For managers and technician  
 To statistic menu to see the daily work and the program utilisation.

For advanced users, managers and technician  
 Possible to download and upload ironing programs.  
 Possible to download statistic reports.

Tutorials  
 Some parts for all users.  
 Other parts for managers only.

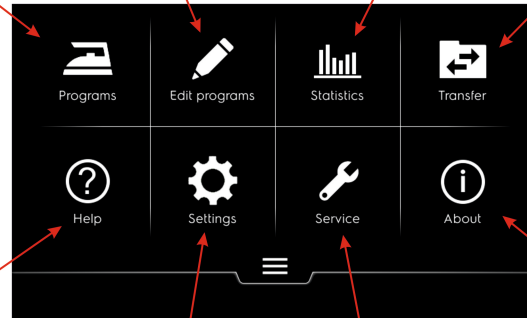

Information about the controller version

For advanced users, managers and technicians  
 Manage the settings of the machine.  
 Restore factory settings ...

For technicians and managers...  
 Reset some error messages.  
 Troubleshooting

**3 Level 0**

**4 Level 1–2**

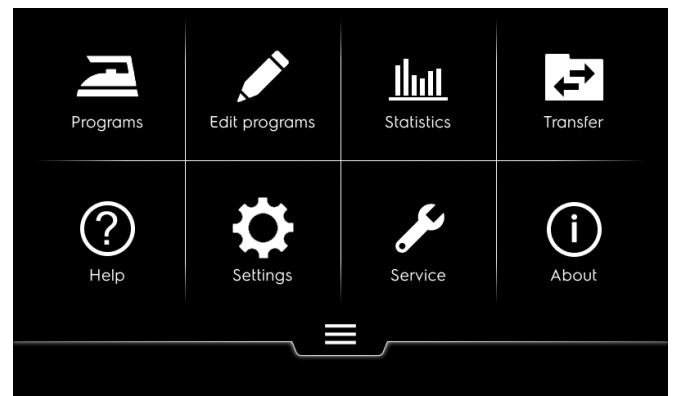
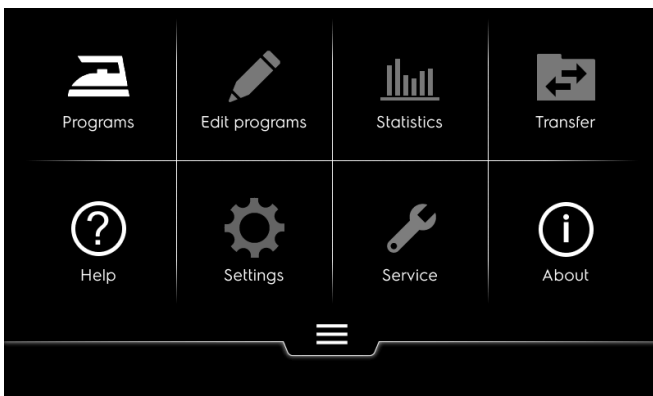

## 7 Use

### 7.1 Power-on daily operation

**1** At power-on the machine will start to show the Electrolux welcome page.



**2** Controller will prevent to make the machine ready for start with some basic recommendations.

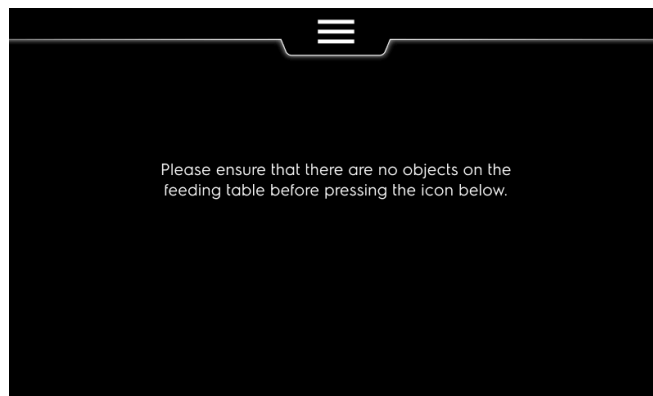

**3** A few seconds after allowing time for the operator to ensure that the machine is ready to work; the icon to start the machine will appear.

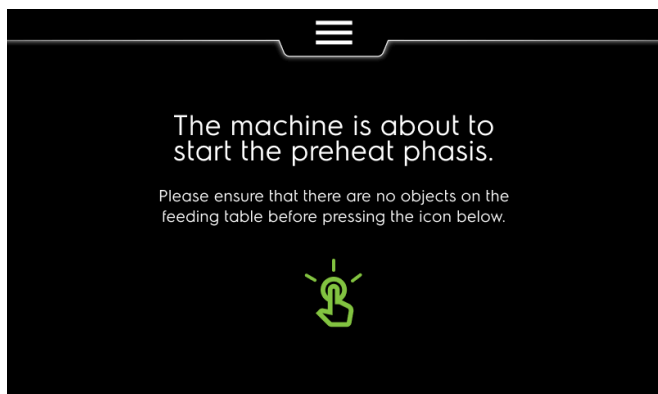

## 7.2 Programs management

In this chapter you find how to run a program, stop and pause it

**1**

To start the machine you have to push on green hand .

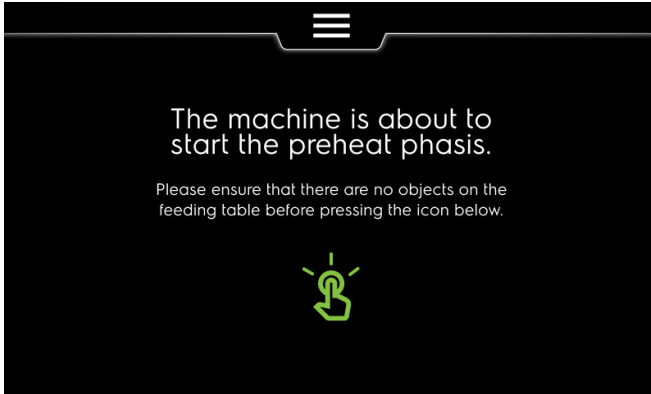
**2**

- By this screen , you can chose either standards Electroluxprofessional programs or customer name to open the list of program of this customer you are working for.

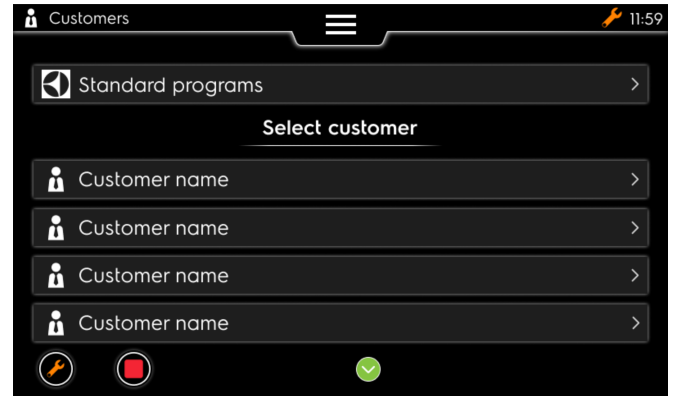

### 7.2.1 Enter ID operator

In this chapter you find how to input the ID of the operator asked in several tasks during the daily work like :

Running a program

Pause during the program resumed.

Service tasks status to change.

**1** You may have this screen to input ID operator

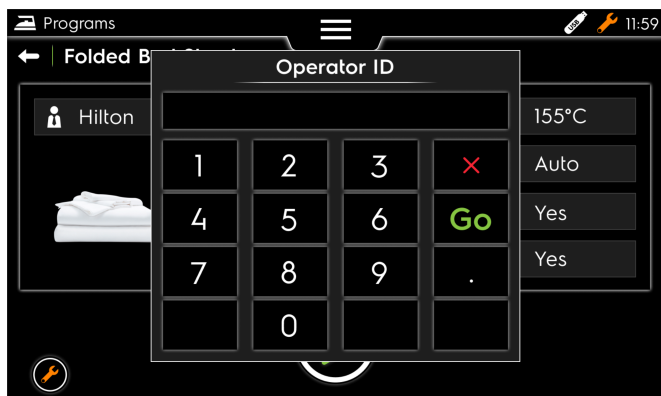

**2** Input the ID of the operator (3 digits max) first digit

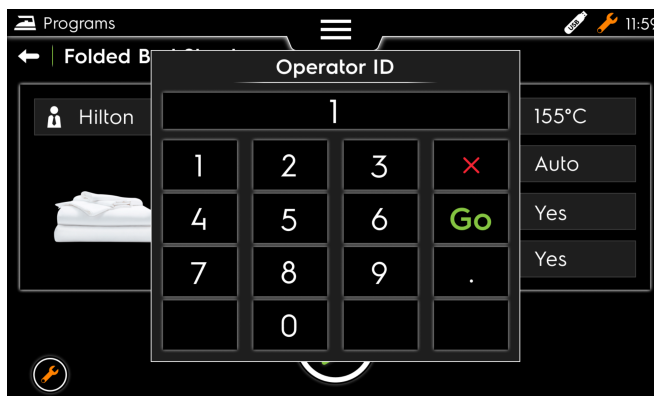

**3** Second digit

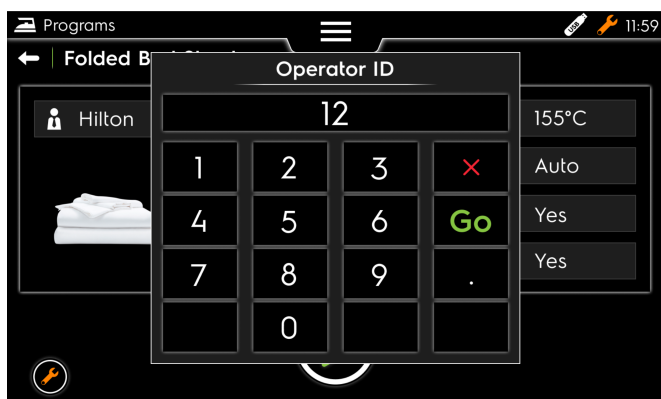

**4** third digit and press "Go"

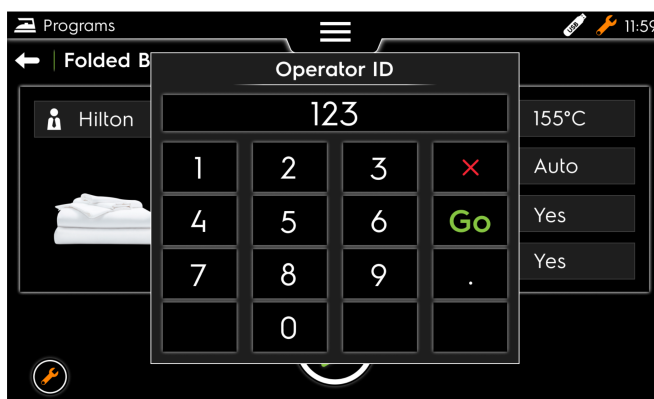

### 7.2.2 Select program

In this chapter you find how to select a program in customer lists.

**1** By this screen , you can chose either standards Electroluxprofessional programs or customer name to open the list of programs of this customer you are working for.

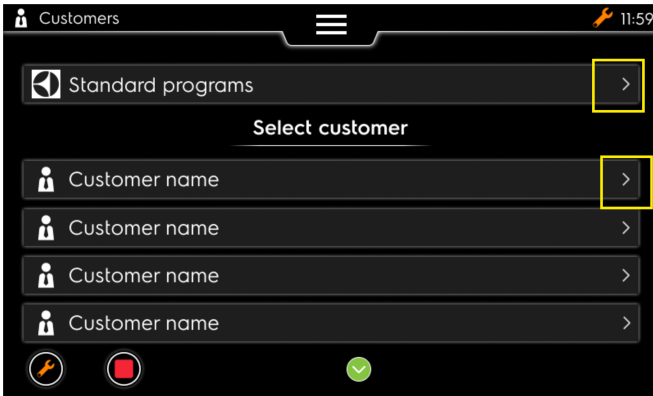

**2** • Select the program you want to work with.

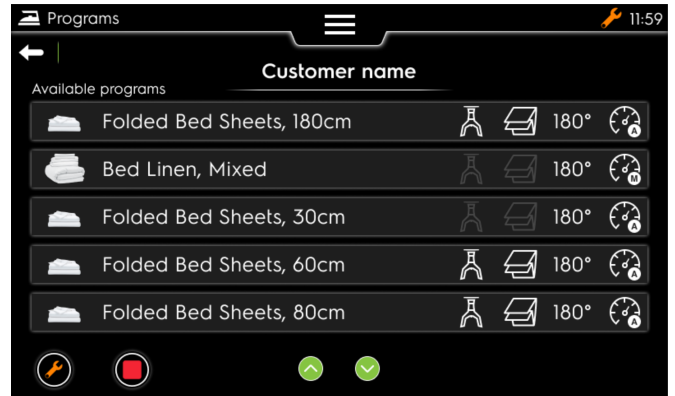

**3** you can skroll down the list of programs of this customer.

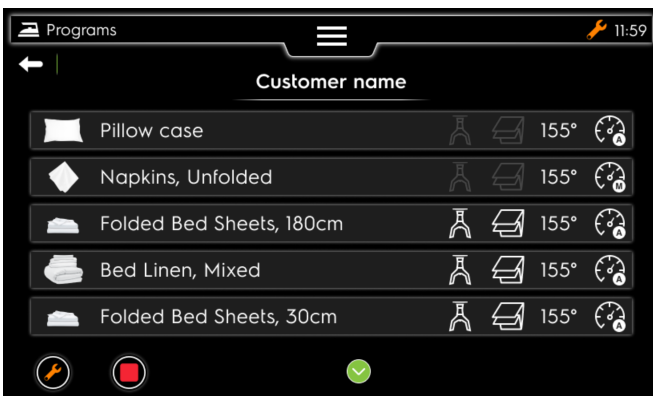

**4** Then the program will be available to work with when the ironing temperature of the program is reached. Please wait.



## 7.2.3 Program running

### 7.2.3.1 Program running

In this chapter you find the different screen of a ironing program.

**1** Program not running until temperature not reached, please wait.

**2**

- New screen when program ready to run .



**3**

You can use the machine and see the different status of the feeder clamps or the heating and speed.





### 7.2.3.2 Pause during program

In this chapter you find how to pause the running program.

- 1 From the program screen, select the pause icon (two white vertical bars)



- 2 • New screen to select the time of the pause ( 5mn minimum ) by pressing "OK" the timer begins.

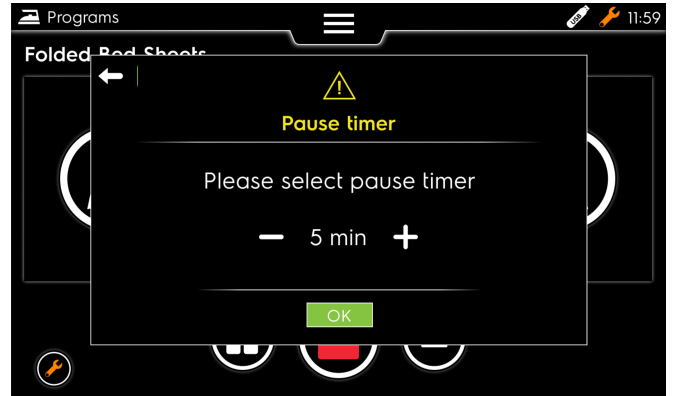

- 3 The timer decrease but you can stop it by pressing "Resume"

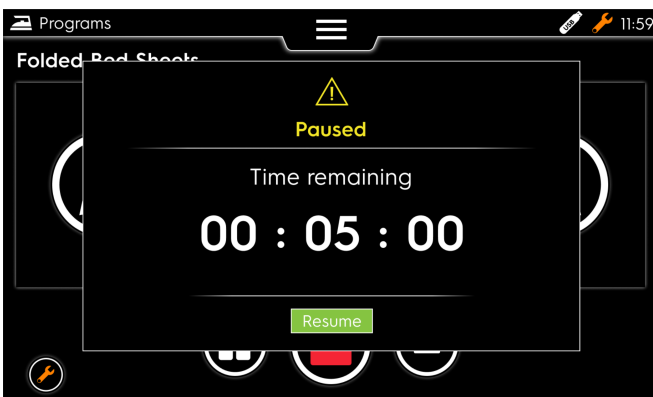

- 4 You need to input ID operator as describe in precedent chapter

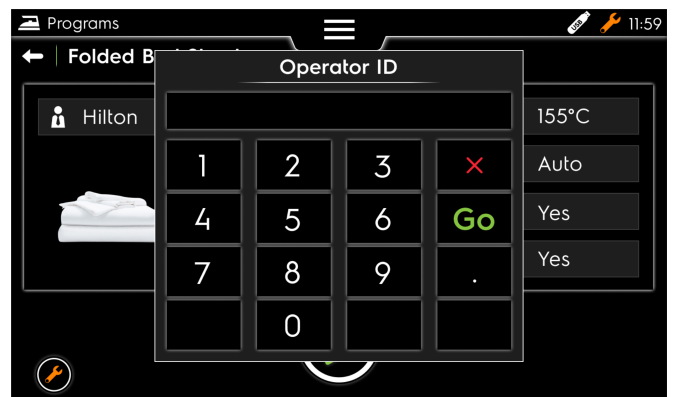

### 7.2.3.3 Stop program

In this chapter you find how to stop a program (stop the machine or continue to work with another program)

**1** From the program screen, select the stop icon (red square).



**2** New screen to select if you want to stop the machine completely or just stop the current program and go back to the program list to select another one.

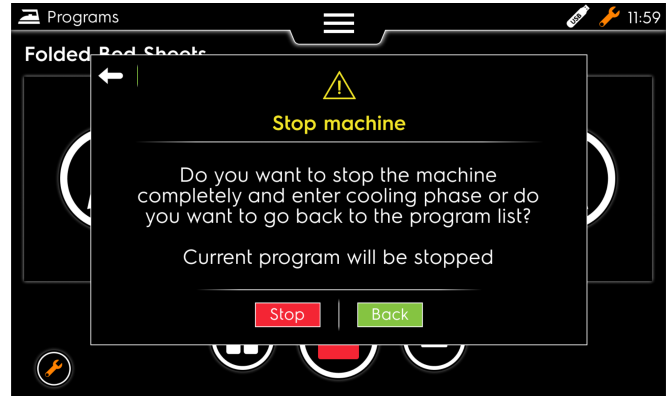

**3** If you select stop in step 2, you will have the following screen to stop the machine.

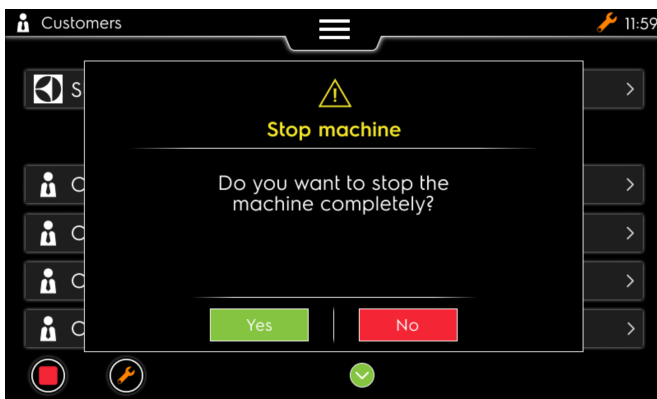

**4** If you select "back" in step 2, you will go back to the customer list!

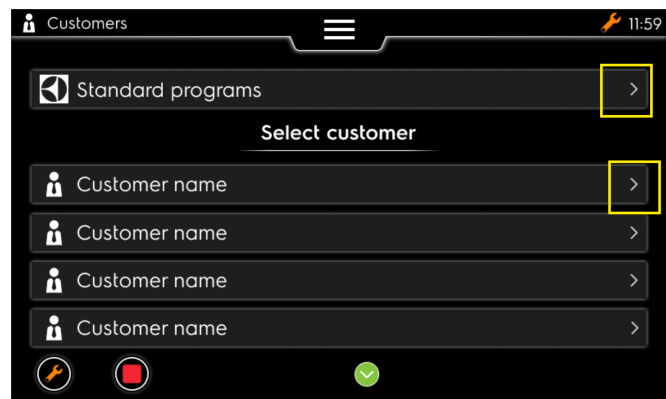

## 7.2.4 See service tasks status

In this chapter you find how to access to the service tasks status during a program running

**1** From the program screen, select the orange key (in yellow square)

**2** • New screen to see the service tasks status.

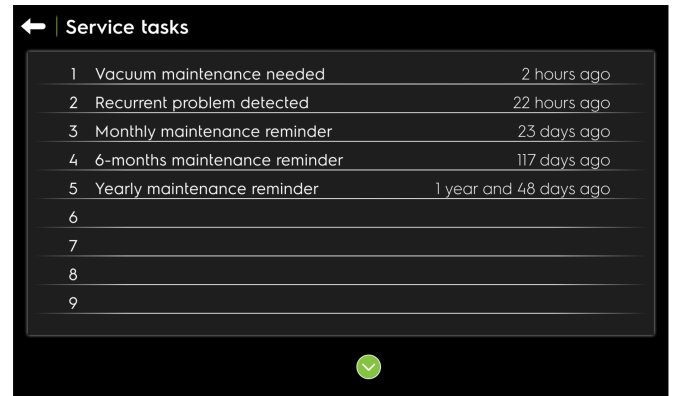

### 7.2.5 Input PIN code to access higher level

In this chapter you find how to enter the PIN code to have access to more informations ( in grey) (need to know this code to have access to higher level (not operator action, but customer or technician)

**1** From the main menu, select a grey icon where you want to go (statistics for example)

**2** • New screen to enter PINCODE (four digits).

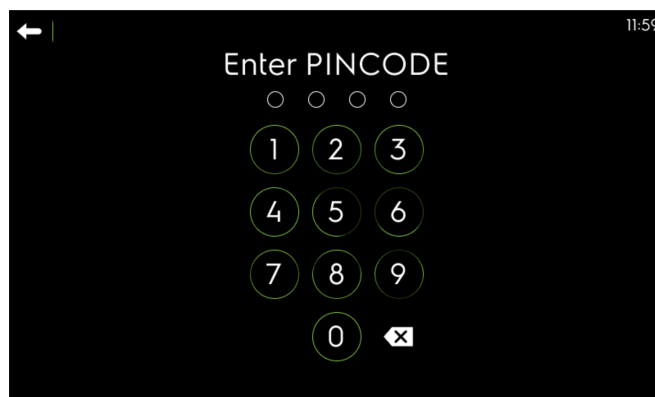
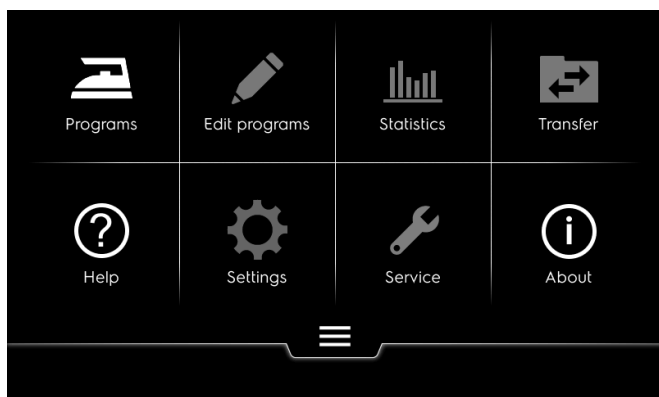

**3** Enter PINCODE (here two digits have been entered).

**4** If you have this screen, you don't enter a right PINCODE to access to the menu selected.

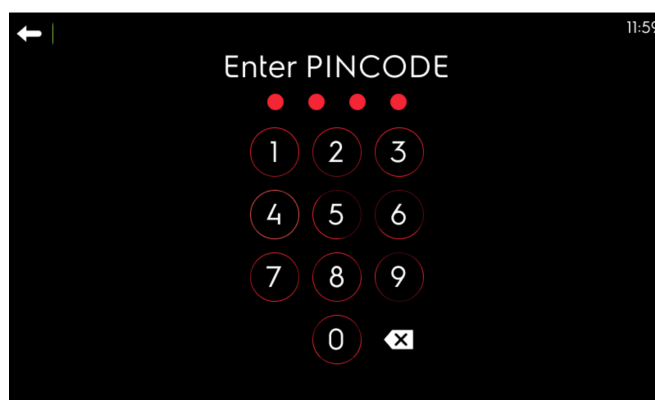
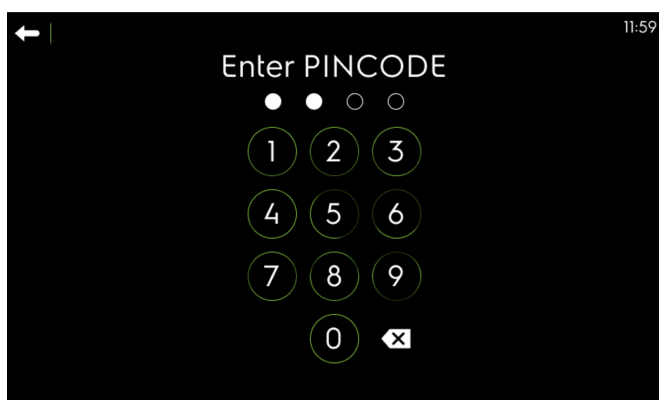

When you enter the fourth digit, and the PINCODE is the right one, automatically you open the screen of the option you want to access.

### 7.3 Ironing

In this chapter, you will find the recommendations for a good ironing of your linen.

### 7.3.1 Use recommendations

- Make sure that the fabric can be ironed, and check which temperature should be used.
- Take care with synthetic and printed fabrics as these can melt and stick to the tray.
- It is advisable to commence ironing with the most delicate fabrics finishing off with the most heat-resistant ones, by progressively increasing the temperature with the thermostat button.
- When ironing small articles, use the entire width of the cylinder so that heat is evenly distributed, preventing wear on only one side of the covering.
- Iron starched articles last, to prevent any eventual residue on the bed from damaging other items.
- Do not iron overly thick linen or covers.
- Do not iron non heat-resistant or overly voluminous buttons (round buttons, for example).
- Carefully inserting the articles to be ironed will improve results.
- Make sure that the width of the ironing does not exceed the useful width of the machine.
- When ironing small items, be sure to alternatively use the full width of the roller (and not simply the middle); this prevents depressions from forming in the middle of the covering. This can effect the quality of the ironing (see figure below).

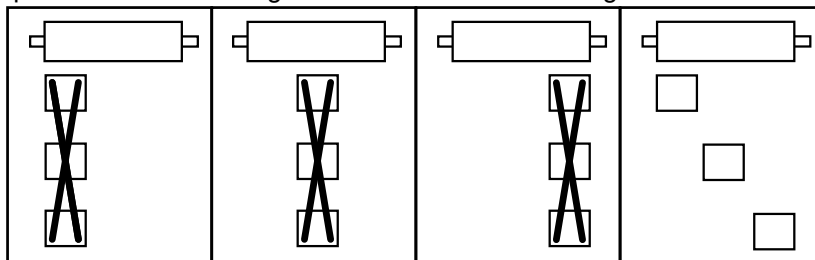

ure below).

- When ironing is finished, let the cylinder turn for a few minutes to allow for the evaporation of any humidity absorbed during ironing.

Caution

74032535

Do not push small pieces of laundry in front of the DIAMMS turners to avoid jamming. The position of the DIAMMS is indicated by the gray feeding belts.

Important

It is very important that the machine is not running cold, the grip between the cylinder and the belts is too important which can prematurely wear out the cylinder padding and deteriorate the free wheel. Failure to follow this recommendation would void the warranty of the parts in question.

The ironing belts being a consumable, it is normal to replace them periodically.

### **7.3.1.1 The use of steam heating machines.**

Steam heating machines are designed to operate only using dry saturated steam at a maximum pressure of 1000 kPa (10 bar). You should take care not to exceed this limit in order to avoid premature damage to pressurised components.

Each time the machine cools down, water vapour is inevitably created. The use of dry saturated steam reduces the risk of erosion and corrosion of the tubes and pressurised components.

There is a risk of deformation, cracking and bursting if pressure levels are used which exceed the recommended 1000 kPa (10 bar) . Check that the safety valve operates correctly in order to avoid the risks of excess pressure building up.

## **7.4 Stopping the machine**

To get the maximum service life from the cylinder coverings, use the following procedure to stop ironing.

1. Position the thermostat to 0 to cut off the heating.
2. Let the cylinder turn in contact with the bed for a few minutes so as to eliminate the moisture from the coverings.
3. Turn off the switch to stop the machine.
4. Turn off the main switch.

---

## 8 Advanced use

### 8.1 PCB Vibe Settings menus

In this chapter you find the different settings available with this new controller.

#### 1. Basic Settings

- Language setting
- Clock setting
- Date setting
- Units setting
- PIN code change
- Customers definition
- Operators creation
- Contact definition

#### 2. Advanced settings

- Machine parameters
- Function parameters
- Machine timers
- Restore factory settings
- Default access level

## 8.2 Basic settings

### 8.2.1 PCB Vibe — Language setting

In this chapter you find how update the language to use (already input during the first connection at the installation of this product.)

**1** From the main menu, select language setting.

**2** • New screen to select the different language to use

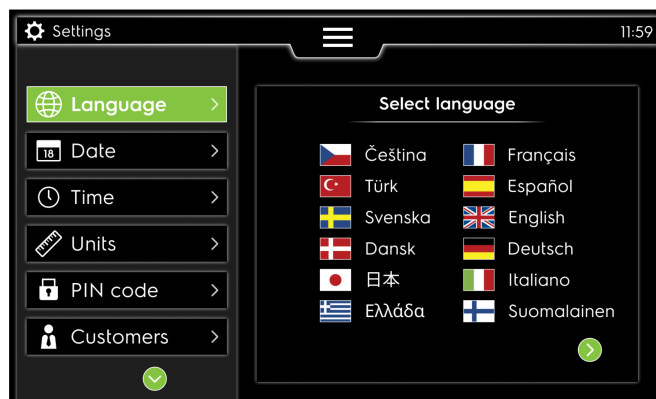
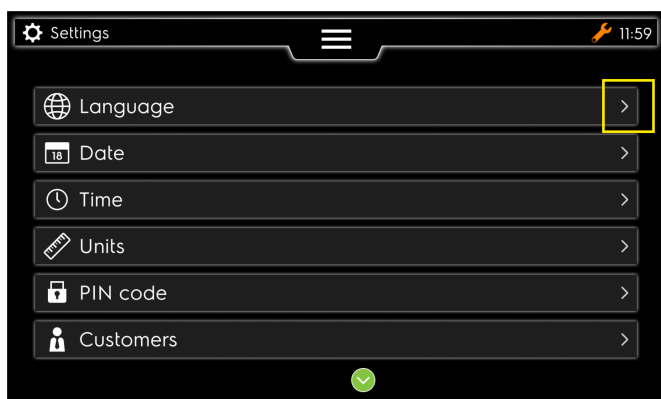

**3** Validate your modification

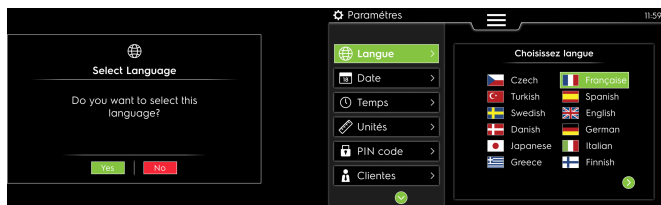



## 8.2.2 PCB Vibe — Clock setting

In this chapter you find how modify the clock (already input during the first connection at the installation of this product.)

**1** From the main menu, select Time setting.

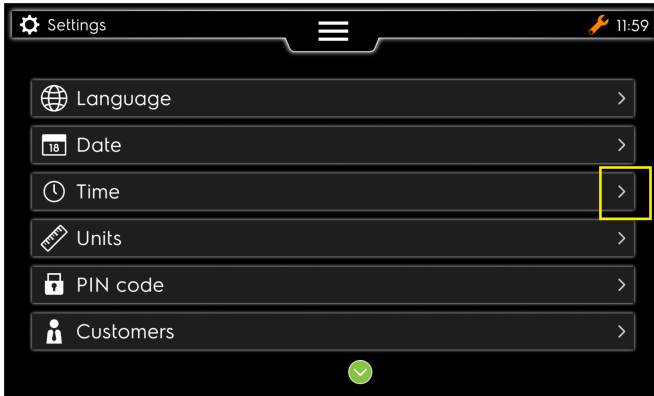

**2** • New screen to select Time zone, time format.

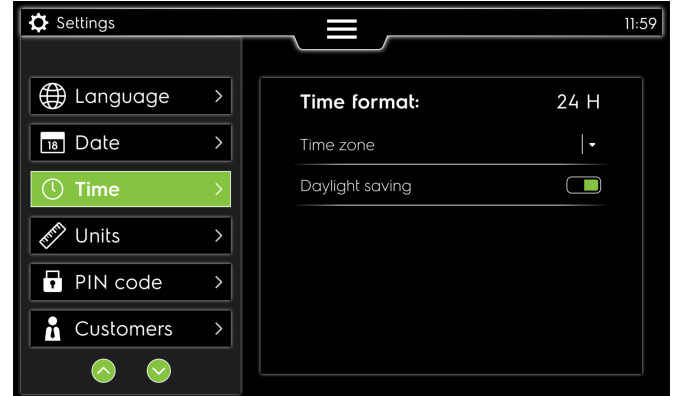

### 8.2.3 PCB Vibe — Date setting

In this chapter you find how update the date of the system

**1** From the main menu, select date setting.

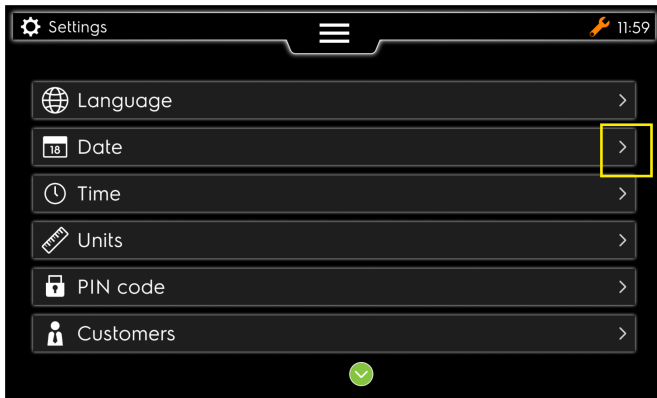

**2** • New screen to select the different component of the date , its format.

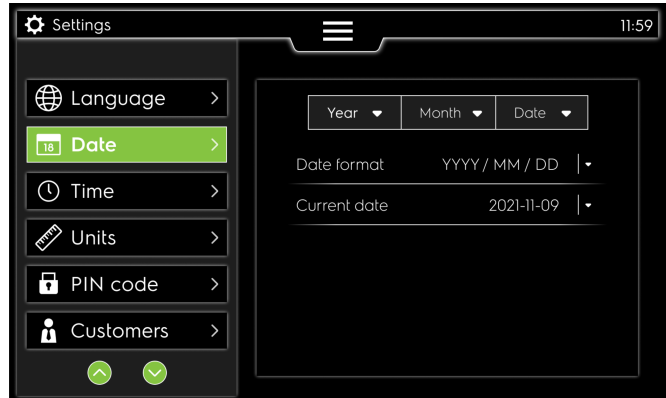

**3** Select the year.

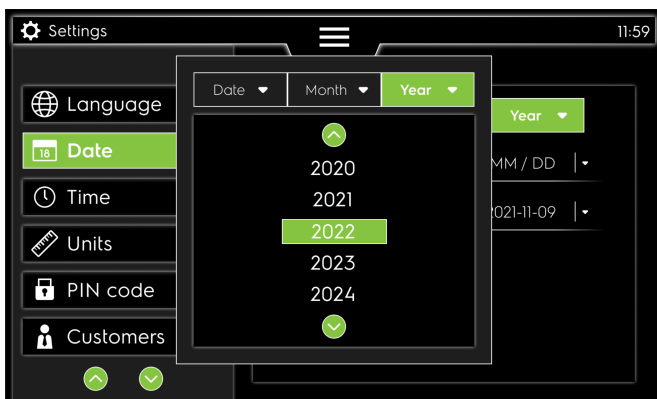

**4** select the month.

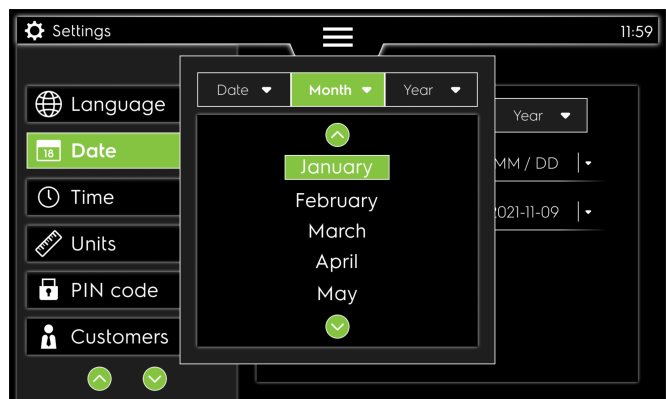

# 5

Select the day of the date

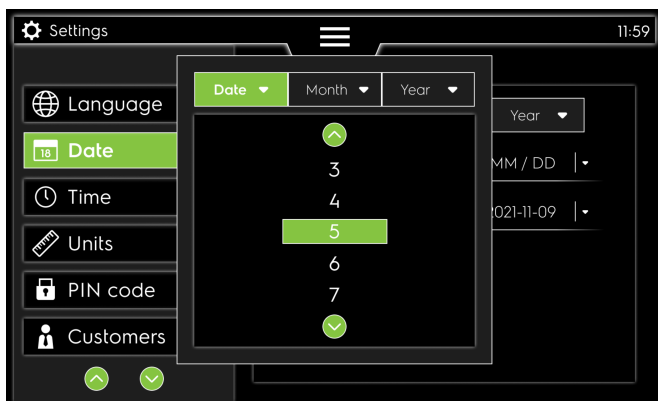

## 8.2.4 PCB Vibe — Units setting

In this chapter you find how update the Units to use (already input during the first connection at the installation of this product.)

**1** From the main menu, select Units setting.

**2** • New screen to select the different Units to use (in this case below : Metrics are selected)

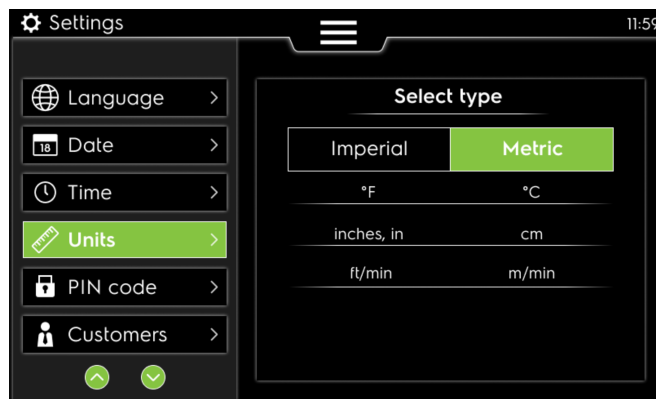
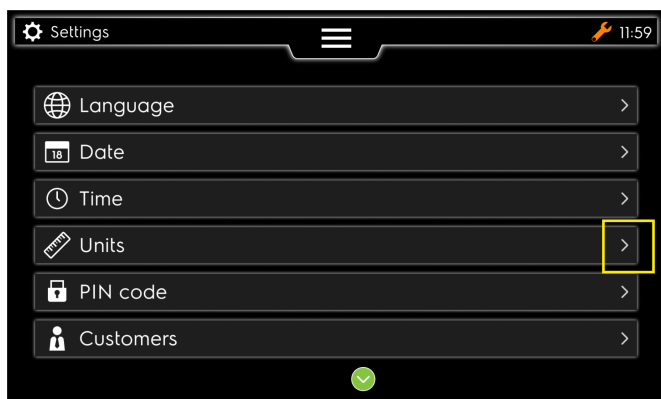

**3** in this case below : Imperial are selected

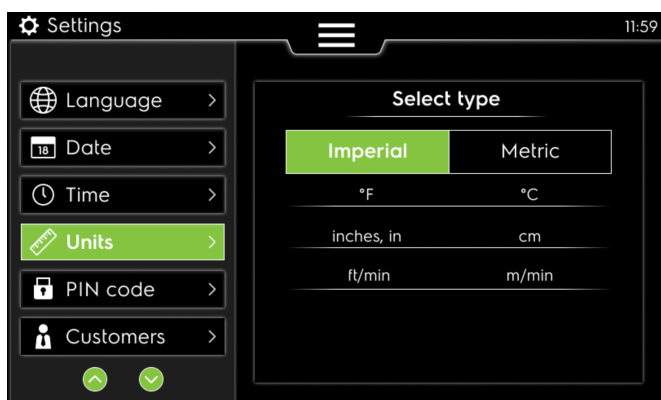

### 8.2.5 PCB Vibe — PIN code setting

In this chapter you find how update the PIN code to use (already input during the first connection at the installation of this product.)

**1** From the main menu, select PIN code setting.

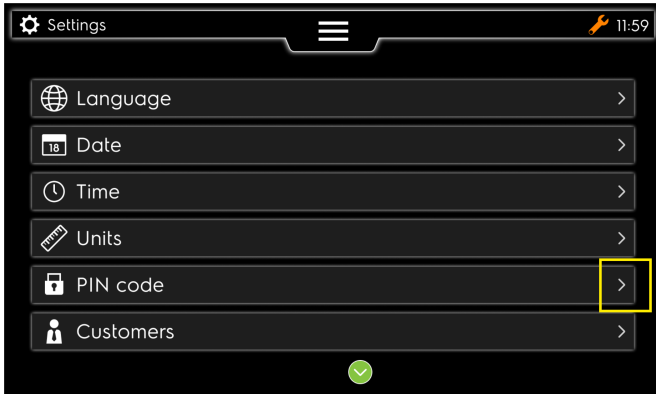

**2** • New screen to select the different PIN code , actual, new one and confirm the new one

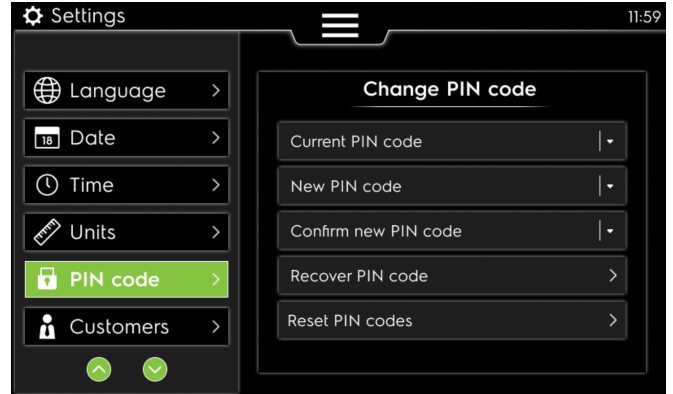

**3** Key board with number to input the different code (new one must have 4 digits)

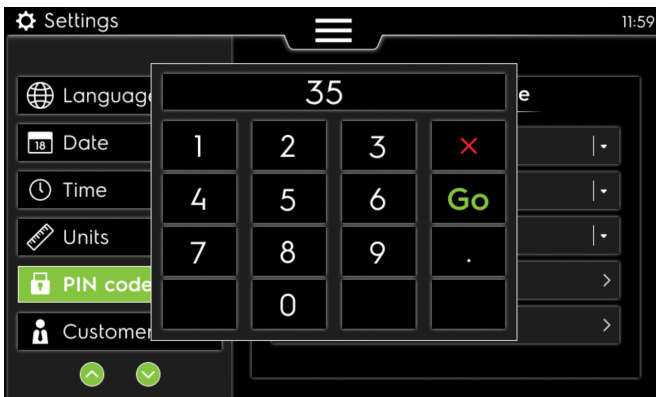

**4** This error can be edited if you 'are not entering the right current code

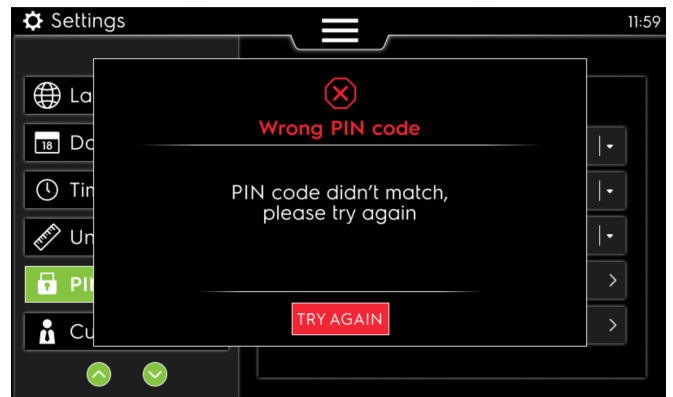

**5** This error can be edited if you 'are not entering enough digits for the code

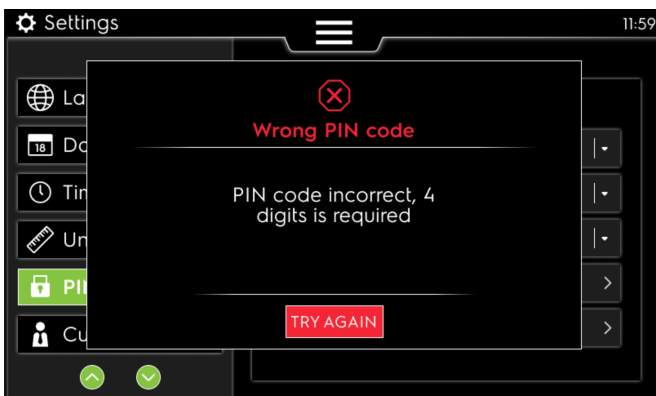

**6** This error can be edited if you 'are not entering a code already used

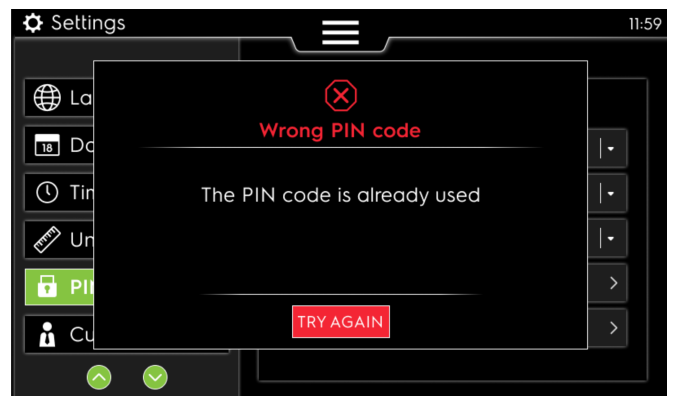

## 8.2.6 PCB Vibe — Customers definition

In this chapter you find how create or delete the customer definition

**1** From the main menu, select customers setting.

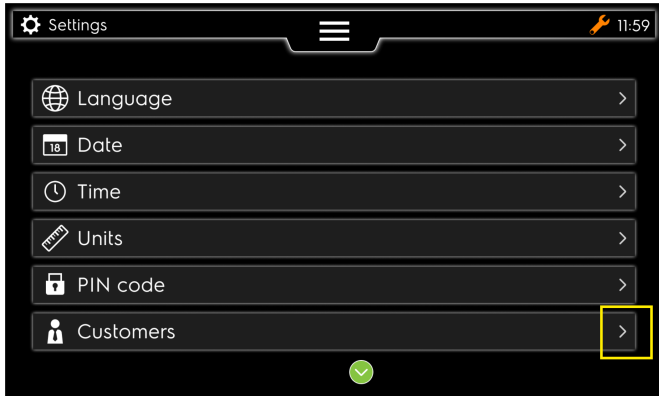

**2** • New screen to add new customer and see the list of customers

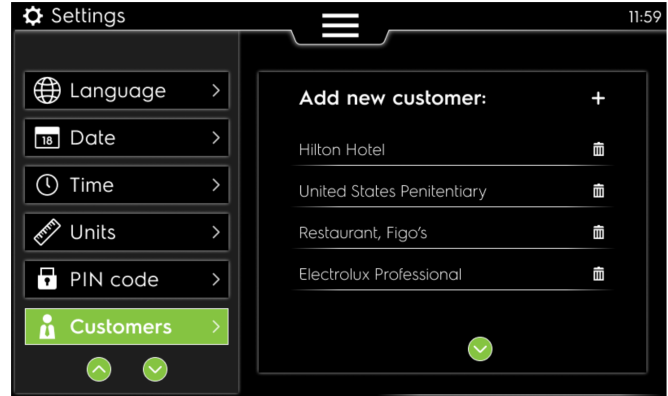

**3** Enter customer name with the keyboard.

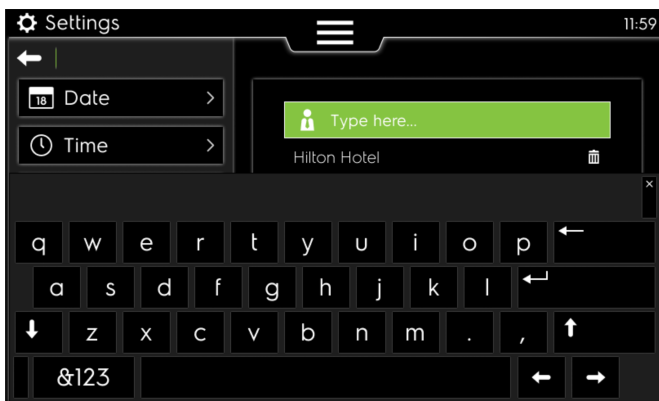

**4** **Delete a customer** : select the dash icon of the customer to deleted and validate the delete of it.

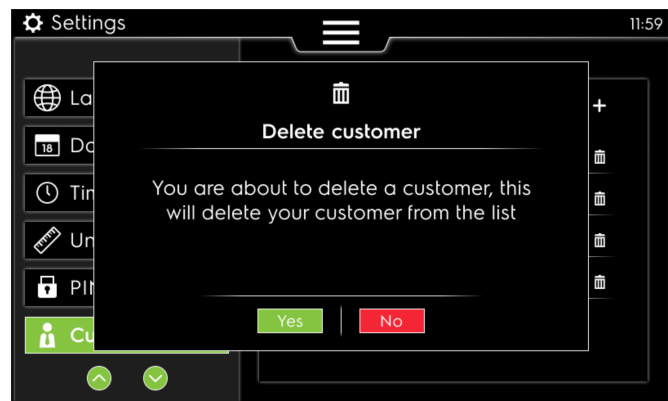

### 8.2.7 PCB Vibe — Operators creation

In this chapter you find how to create or delete an operator ID (already input during the first connection at the installation of this product.)

**1** From the main menu, select Operators setting.

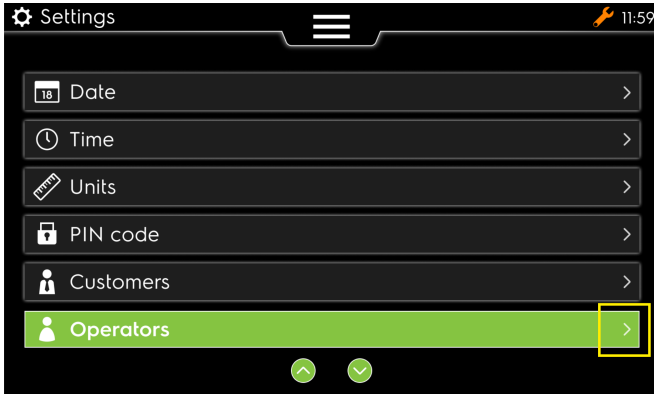

**2** New screen with the list of operators, if you take an action on this screen you will see directly the tutorials of the operators setting ( to skip this tutorial, see following point 3 )

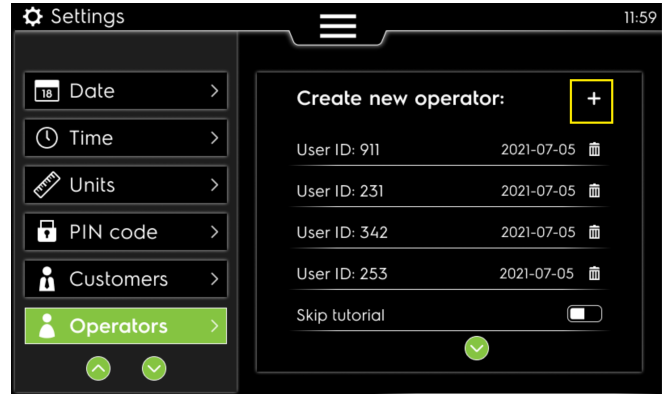

**3** Select Skip tutorial to keep in the setting of operator ID definition ( in green )

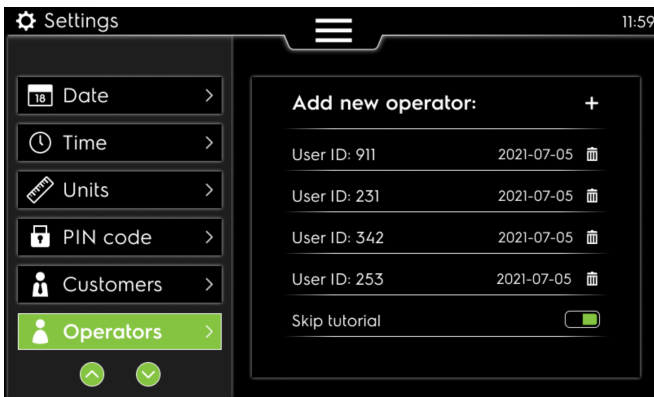

**4** Select ID number to open the input screen

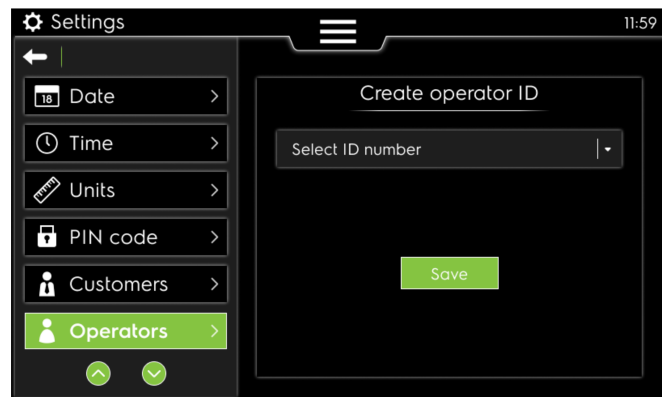

**5** Key board with number to input the new operator ID and then GO

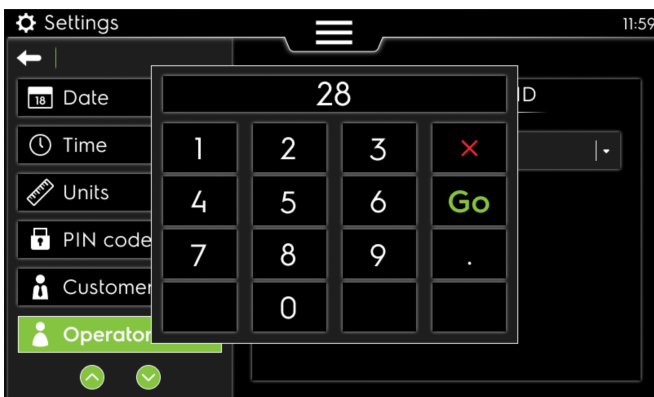

**6** Validate the saving of the new operator ID

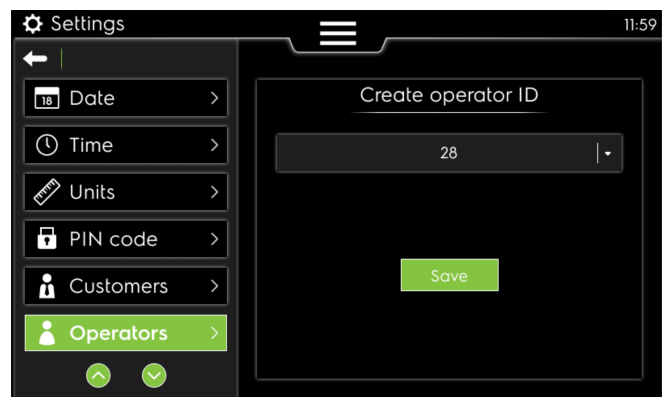

## 7

By press the dash icon in the list, you can delete the operator ID selected, and validate this action by "Yes" in this screen.

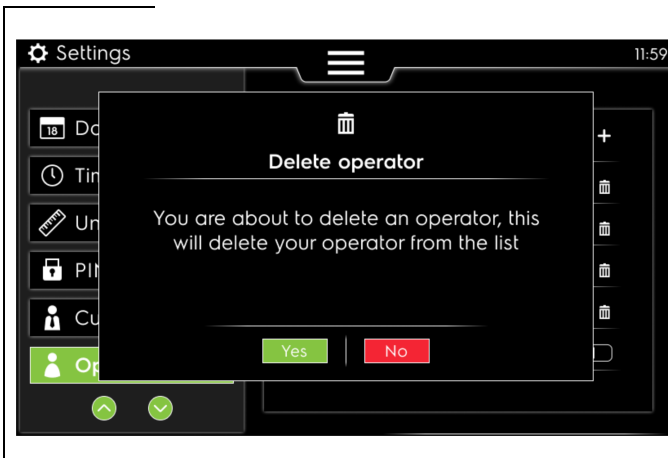



### 8.2.8 PCB Vibe — Contact definition

In this chapter you find how modify the contact definition (already input during the first connection at the installation of this product.)

**1** From the main menu, select contact setting.

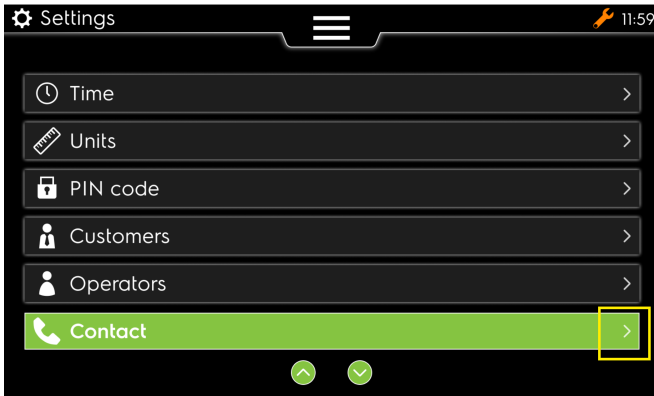

**2** • New screen to select country calling code and phone number.

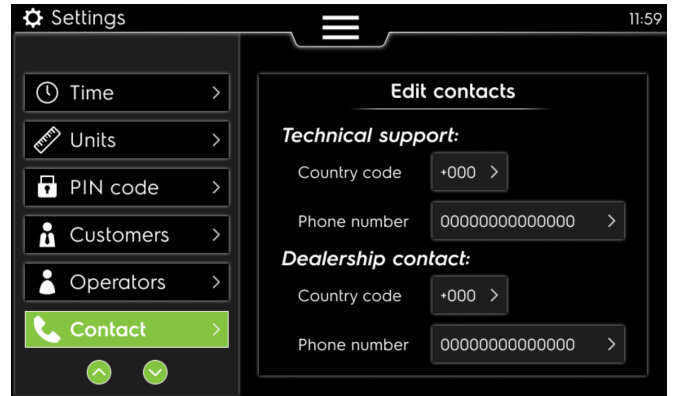

**3** Enter country calling code for technical support or dealership contact.

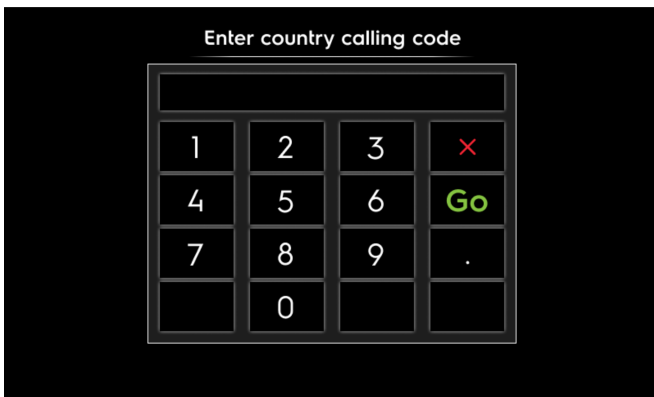

**4** Enter phone number for technical support or dealership contact.

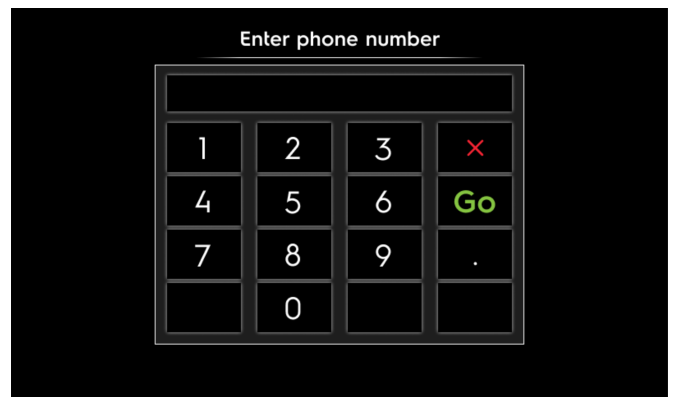

## 8.3 Advanced settings

### 8.3.1 PCB Vibe — Machine parameters

In this chapter you find the different settings for machine parameters with this new controller.

**1** From the main menu, select **Advanced settings** and **Machine parameters**.

**2** • New screen to adjust the machine parameters if needed. These data have been set up during the factory settings and normally you don't have to change them.

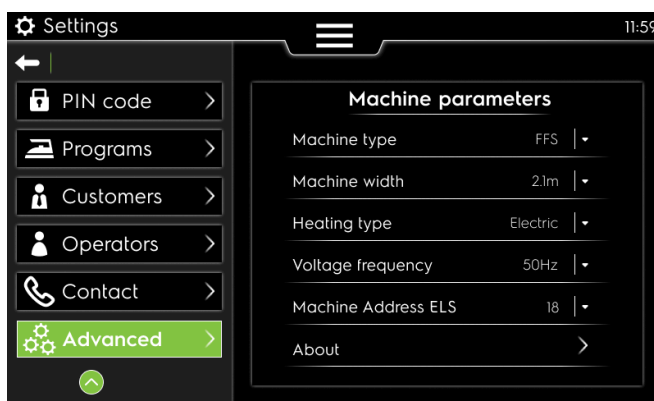
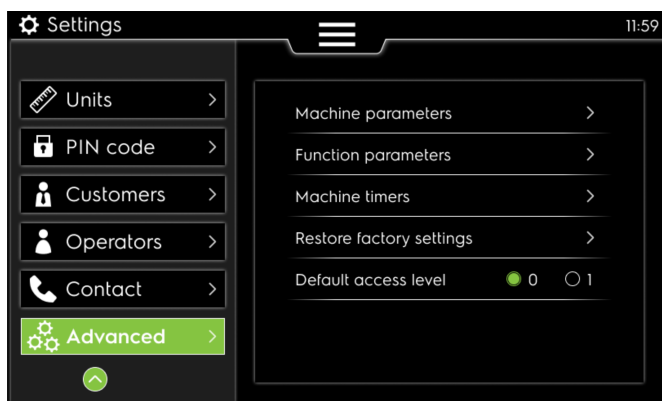

### 8.3.2 PCB Vibe — Function parameters

In this chapter you find the different settings for function parameters available with this new controller.

**1** From the main menu, select **Advanced settings** and **Function parameters**.

**2** • New screen to adjust the function parameters if needed.

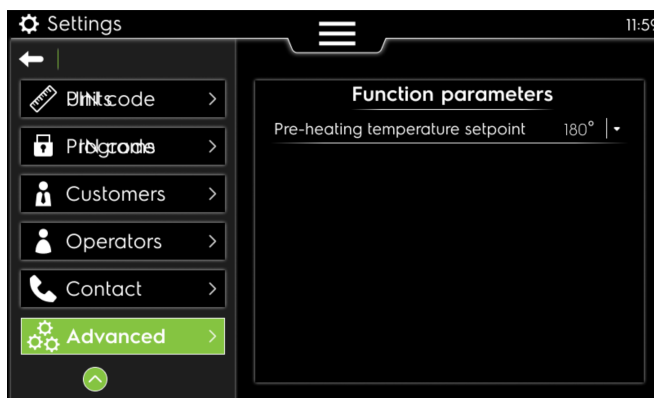
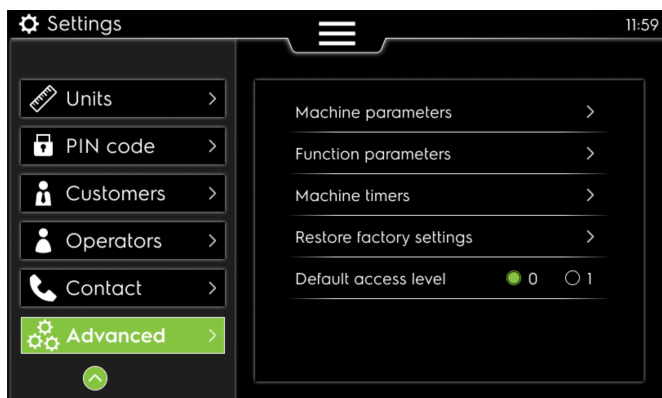

### 8.3.3 PCB Vibe — Machine timers

In this chapter you find the settings of the timers of the machine.

**1** From the main menu, select **Advanced settings** and **Machine timers**

**2** • New screen to select the different timers of the machine and adjust them if needed.

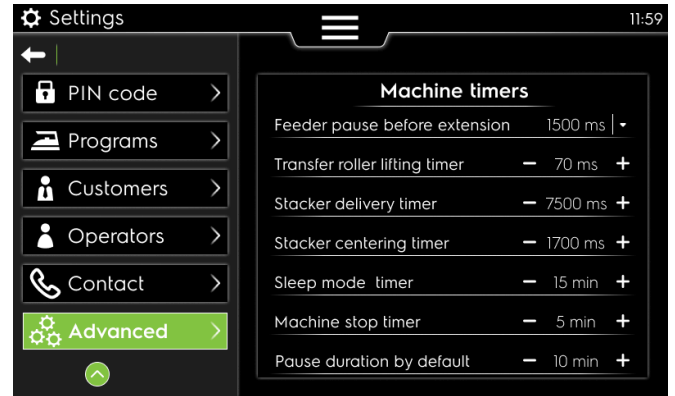
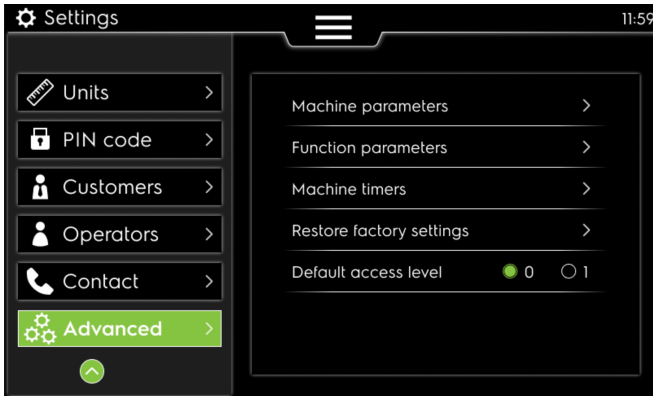

### 8.3.4 PCB Vibe — Restore factory settings

The PCB controller allows the restoration of the factory settings. As customer, you will **NEVER have the right to use this option.**

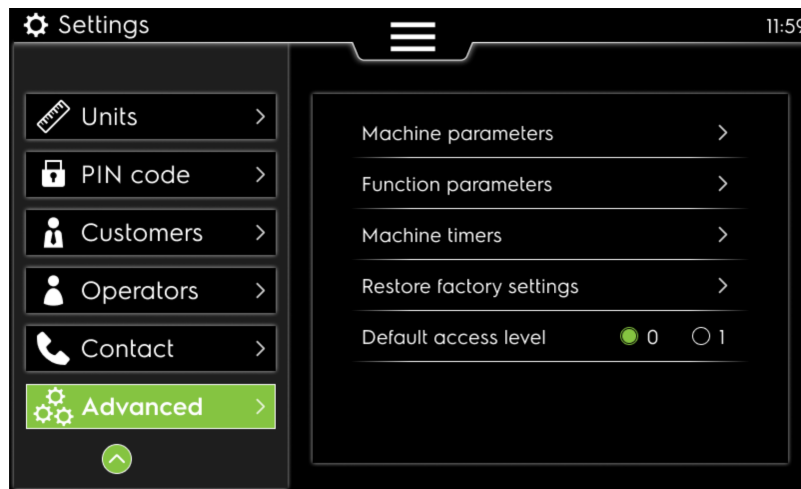

### 8.3.5 PCB Vibe — Default access level

In this chapter you find the advanced setting to fix the level access by default.

**1**

From the main menu, select advanced setting.

**2**

• Select 1 or 0 as default access level.

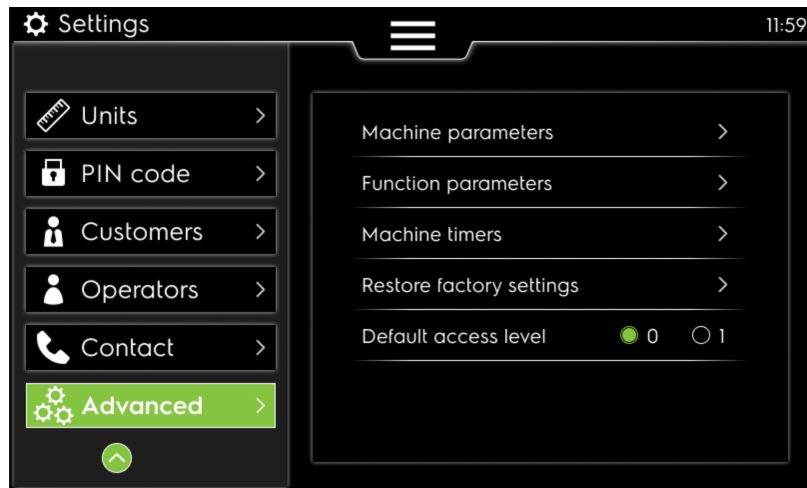

## 9 Errors codes

In this chapter you find the explanation of the errors codes displayed on the screen

For your information there are five different section of errors to help you to know where to go and search the problems :

From error code 001 to 099 : Machine status

From error code 100 to 199 : Feeder errors

From error code 200 to 299 : Longitudinal folding errors

From error code 300 to 399 : Cross folding errors

From error code 400 to 499 : Stacker errors

### 9.1 Error code 01 — Emergency stop

In this chapter you find the explanation of the screen “Error code 01”

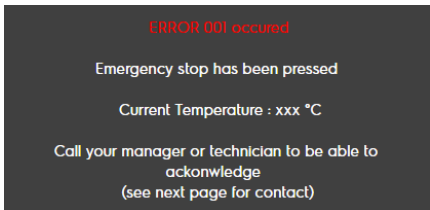
Screen	Cause	Actions
	<p>One emergency button has been pressed.</p> <p>Abnormal or dangerous running of the machine.</p>	<p>Machine is stopped.</p> <p>Release the emergency stop button in a clockwise direction. You need to enter level 1 PIN code quickly to be able to restart the machine. see the paragraph use/PIN code</p> <p>You need to know why the emergency stop had been pressed, and solve the problem before to restart the machine.</p>

### 9.2 Error code 02 — Gas pressure

In this chapter you find the explanation of the screen “Error code 02”

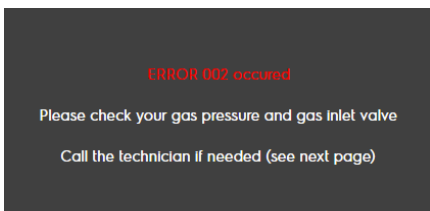
Screen	Cause	Actions
	<p>A slight drop in gas pressure has been detected :</p> <p>Manual gas valves are close. No gas in main supply.</p> <p>Heating , antistatic bar and vacuum are stopped.</p>	<p>Validate the error popup. After check the gas supply. Then the program continue and the temperature regulation too.</p>

### 9.3 Error code 03 — Gas ignition

In this chapter you find the explanation of the screen “Error code 03”

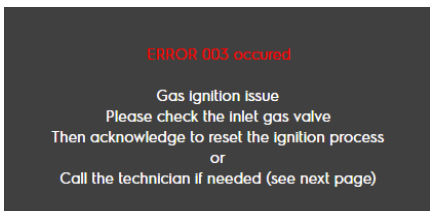
Screen	Cause	Actions
	<p>The gas burner does not start.</p> <p>No gas in connection. No gas in burner. No flame in burner.</p> <p>This error appears after 5 seconds (EC gas) or 15 seconds (Australian gas) where no gas entry into the burner.</p> <p>Heating, antistatic bar and vacuum are stopped.</p>	<p>If the problem is solved : Validate the popup to remain into the program. Then the heating regulation restarts.</p> <p>Check gas main supply. Check the Y1/Y2 gas electrovalves. Check the E2/E3 ignition electrodes.</p>

### 9.4 Error code 04 — Contactors failure

In this chapter you find the explanation of the screen “Error code 04”

Screen	Cause	Actions
<p style="text-align: center;"><b>ERROR 004 occurred</b></p> <p style="text-align: center;">Heating contactors CRITICAL ERROR</p> <p>The machine will go into non folding mode, then: - DISCONNECT THE MAIN POWER and - crank manually the handle while feeding wet linen</p> <p style="text-align: center;">Call immediately the technician (see next page)</p> <p style="text-align: center;">Current Temperature: xxx °C</p>	<p>Electric heating machine :</p> <p>No heating activated during 6 seconds. Desactivation of feeding and folding system; cylinder motion forced to 3m/mn</p>	<p>Reset this error only in service task ( need to login as Level 1 minimum) in service menu.</p> <p>When error disappear, the program is stopped and the first page is displayed (with green hand) need to restart the preheating and select new program;</p>

## 9.5 Error code 05 — Overheating

In this chapter you find the explanation of the screen “Error code 05”

Screen	Cause	Actions
<p style="text-align: center;"><b>Error 005 occurred</b></p> <p style="text-align: center;">Overheating detected</p> <p>Start to feed wet linen inside the machine All linens will be rear ejected in the meantime</p> <p style="text-align: center;">Call the technician if needed (see next page)</p> <p>Current Temperatures (&lt; 195°C to acknowledge) LEFT: xxx °C CENTER : xxx°C RIGHT: xxx°C</p>	<p>After 3 second , one of the 3 temperature sensor PT100 is still over 230°C The heating is stopped, buzzer is activated during 2 minutes</p> <p>The folding is desactivated and the feeding is switched to automatic mode. Cylinder motion is forced to 3 m/mn</p>	<p>Start to feed wet linen to cool the cylinder. these linen will be rear ejected without folding. When the temperature sensors PT100 are below 195°C You can validate the error (Level 0 allowed) The program is stopped and the first page is displayed (with green hand)</p>

## 9.6 Error code 06 — Overheating bis

In this chapter you find the explanation of the screen “Error code 06”

Screen	Cause	Actions
<p style="text-align: center;"><b>Error 006 occurred</b></p> <p style="text-align: center;">Too many overheating errors</p> <p>Start to feed wet linen inside the machine All linens will be rear ejected in the meantime</p> <p style="text-align: center;">Call immediately the technician (see next page)</p> <p>Current Temperatures (&lt; 195°C to acknowledge) LEFT: xxx °C CENTER : xxx°C RIGHT: xxx°C</p>	<p>Too many errors 005 are activated. (more than 5)</p> <p>After 3 second , one of the 3 temperature sensor PT100 is still over 230°C</p> <p>The heating is stopped, buzzer is activated during 2 minutes. The folding is desactivated and the feeding is switched to automatic mode.</p> <p>The cylinder motion is forced to 3m/mn</p>	<p>Start to feed wet linen to cool the cylinder. these linen will be rear ejected without folding. When the temperature sensors PT100 are below 195°C You can validate the error (Level 0 allowed) The program is stopped and the first page is displayed (with green hand)</p> <p>Error reset can only be done via service task in service menu (level 1 minimum allowed)</p>

## 9.7 Error code 07 — Transmission

In this chapter you find the explanation of the screen “Error code 07”

Screen	Cause	Actions
<p style="text-align: center;"><b>Error 007 occurred</b></p> <p style="text-align: center;">There is an issue with the main transmission</p> <p>If the feeding bell are stopped and the temperature is above 100°C please: - call IMMEDIATELY the technician (see next page) - crank the handle while feeding wet linen</p> <p style="text-align: center;">Current Temperature: xxx °C</p>	<p>The heating is stopped. The folding has to be desactivated if program with folding after transfer into cross done The feeding is switched to automatic mode.</p> <p>The cylinder motion is forced to 3m/mn</p>	<p>You can validate the error (Level 0 allowed) The program is stopped and the first page is displayed (with green hand)</p> <p>Error reset can only be done via service task in service menu (level 1 minimum allowed)</p>

### 9.8 Error code 08 — Thermal fuse

In this chapter you find the explanation of the screen “Error code 08”

Screen	Cause	Actions
	<p>The thermal fuse has tripped. The heating is stopped. The folding has to be desactivated if program with folding after transfer into cross done The feeding is switched to automatic mode.</p> <p>The cylinder motion is forced to 3m/mn</p>	<p>Start to feed wet linen to cool the cylinder. these linen will be rear ejected without folding. When the temperature sensors PT100 are below 195°C You can validate the error (Level 0 allowed) The program is stopped and the first page is displayed (with green hand) Error reset can only be done via service task in service menu (level 1 minimum allowed)</p>

### 9.9 Error code 09 — Safety thermostat

In this chapter you find the explanation of the screen “Error code 09”

Screen	Cause	Actions
	<p>The safety thermostat has tripped. The temperature of the the cylinder is too high ( around 215°C) You may deteriorate the ironing belts and your linen too.</p> <p>The heating is stopped. The folding has to be desactivated if program with folding after transfer into cross done The feeding is switched to automatic mode.</p> <p>Buzzer activation during 2 minutes The cylinder motion is forced to 3m/mn</p>	<p>Start to feed wet linen to cool the cylinder. these linen will be rear ejected without folding. When the temperature sensors PT100 are below 195°C You can validate the error (Level 0 allowed) The program is stopped and the first page is displayed (with green hand)</p>

### 9.10 Error code 10 — Safety thermostat bis

In this chapter you find the explanation of the screen “Error code 10”

Screen	Cause	Actions
	<p>The safety thermostat has tripped. The temperature of the the cylinder is too high ( around 215°C) You may deteriorate the ironing belts and your linen too. It's too many time that this error (009) appears(five times) The heating is stopped. The folding has to be desactivated if program with folding after transfer into cross done The feeding is switched to automatic mode.</p> <p>Buzzer activation during 2 minutes The cylinder motion is forced to 3m/mn</p>	<p>Start to feed wet linen to cool the cylinder. these linen will be rear ejected without folding. When the temperature sensors PT100 are below 195°C You can validate the error (Level 0 allowed) The program is stopped and the first page is displayed (with green hand)</p> <p>Error reset can only be done via service task in service menu (level 1 minimum allowed) Call a technician .</p>

### 9.11 Error code 11 — Exhaust issue

In this chapter you find the explanation of the screen “Error code 11”

Screen	Cause	Actions
<p style="text-align: center;"><b>Error 011 occurred</b></p> <p style="text-align: center;">Issue with the exhaust system</p> <p style="text-align: center;">Call the technician if needed (see next page)</p>	<p>The pressostat has detected an issue in the exhaust system. Need perhaps to be vacuum. The heating is stopped. The cylinder continues to rotate.</p>	<p>You can validate the error (Level 0 allowed) The program continues if the pressostat of exhaust is ok</p> <p>The regulation of the heating restarts.</p>

## 9.12 Error code 12 — Feeder protection

In this chapter you find the explanation of the screen “Error code 12”

Screen	Cause	Actions
<p style="text-align: center;"><b>Error 012 occurred</b></p> <p style="text-align: center;">Feeder protection activated</p> <p style="text-align: center;">Please remove the potential jam on the feeding table</p> <p style="text-align: center;">Call the technician if needed (see next page)</p>	<p>The mobile feeder protection has been activated by pressure on it by the operator or by the linen. The heating is stopped. The program is stopped and the motion too.</p>	<p>Please remove the jam on the feeding table You can validate the error (Level 0 allowed) The program is stopped and the first page is displayed (with green hand)</p> <p><b>CAUTION :</b> Do it quickly in order not to deteriorate the ironing belts if the cylinder is too hot; Motion stopped !!</p>

## 9.13 Error code 100 — Feeder clamp sensor left

In this chapter you find the explanation of the screen “Error code 100”

Screen	Cause	Actions
<p style="text-align: center;"><b>Error 100 occurred</b></p> <p style="text-align: center;">Issue with the left clamp sensor</p> <p style="text-align: center;">Wait until the machine is empty to be able to acknowledge this message</p> <p style="text-align: center;">Call the technician if needed (see next page)</p>	<p>error displayed if :</p> <p>left clamp is activated for more than 10 minif program with feeder activated AND left clamp sensor activated after pressing release button + 500ms</p> <p>program with feeder activated AND left clamp sensor activated after middle release on table + 500ms</p>	<p>You can validate the error (Level 0 allowed) if machine is empty. The program is stopped and the first page is displayed (with green hand) Error reset can only be done via service task in service menu (level 1 minimum allowed) Only programs without Feeder will be authorized until the reset of this error.</p>

## 9.14 Error code 101 — Feeder clamp sensor right

In this chapter you find the explanation of the screen “Error code 101”

Screen	Cause	Actions
<p style="text-align: center;"><b>Error 101 occurred</b></p> <p style="text-align: center;">Issue with the right clamp sensor</p> <p style="text-align: center;">Wait until the machine is empty to be able to acknowledge this message</p> <p style="text-align: center;">Call the technician if needed (see next page)</p>	<p>error displayed if :</p> <p>right clamp is activated for more than 10 minif program with feeder activated AND right clamp sensor activated after pressing release button + 500ms</p> <p>program with feeder activated AND right clamp sensor activated after middle release on table + 500ms</p>	<p>You can validate the error (Level 0 allowed) if machine is empty. The program is stopped and the first page is displayed (with green hand) Error reset can only be done via service task in service menu (level 1 minimum allowed) Only programs without Feeder will be authorized until the reset of this error.</p>

## 9.15 Error code 102 — Feeder clamps position switch

In this chapter you find the explanation of the screen “Error code 102”

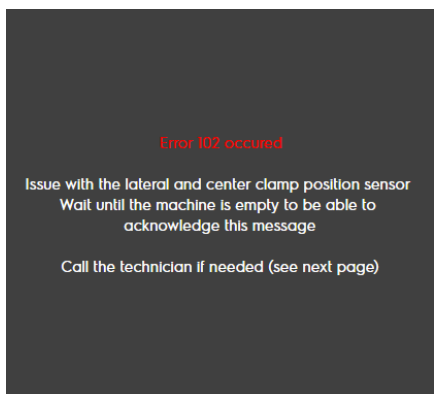

Screen	Cause	Actions
 <p style="text-align: center; color: red;">Error 102 occurred</p> <p>Issue with the lateral and center clamp position sensor Wait until the machine is empty to be able to acknowledge this message</p> <p>Call the technician if needed (see next page)</p>	<p>error displayed if :</p> <p>if clamp lateral position and clamp center position are activated at the same time. If program with feeder activated, stop feeder motion. Force clamp left and right opening</p>	<p>You can validate the error (Level 0 allowed) if machine is empty. The program is stopped and go to program list Error reset can only be done via service task in service menu (level 1 minimum allowed) Only programs without Feeder will be authorized until the reset of this error.</p>

### 9.16 Error code 103 — Feeder clamp center position

In this chapter you find the explanation of the screen “Error code 103”

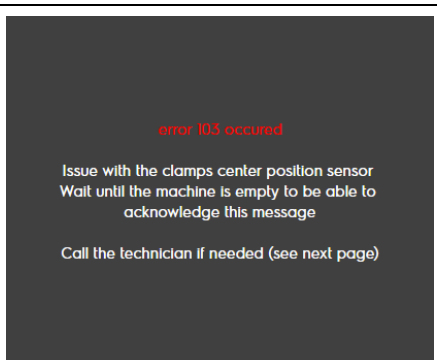
Screen	Cause	Actions
 <p style="text-align: center; color: red;">error 103 occurred</p> <p>Issue with the clamps center position sensor Wait until the machine is empty to be able to acknowledge this message</p> <p>Call the technician if needed (see next page)</p>	<p>error displayed if :</p> <p>output "bring the clamps in center position" is activated and after 3 seconds the center sensor is still not activated If program with feeder activated, stop feeder motion. Force clamp left and right opening</p>	<p>You can validate the error (Level 0 allowed) if machine is empty. The program is stopped and go to program list Error reset can only be done via service task in service menu (level 1 minimum allowed) Only programs without Feeder will be authorized until the reset of this error.</p>

### 9.17 Error code 104 — Feeder clamp lateral position

In this chapter you find the explanation of the screen “Error code 104”

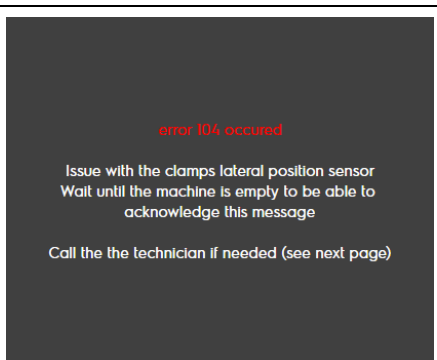
Screen	Cause	Actions
 <p style="text-align: center; color: red;">error 104 occurred</p> <p>Issue with the clamps lateral position sensor Wait until the machine is empty to be able to acknowledge this message</p> <p>Call the the technician if needed (see next page)</p>	<p>error displayed if :</p> <p>output "spread the clamps in lateral position" is activated (after linen release on table) and after 3 seconds the lateral sensor is still not activated If program with feeder activated, stop feeder motion. Force clamp left and right opening</p>	<p>You can validate the error (Level 0 allowed) if machine is empty. The program is stopped and go to program list Error reset can only be done via service task in service menu (level 1 minimum allowed) Only programs without Feeder will be authorized until the reset of this error.</p>

### 9.18 Error code 105 — Feeder trailer switches

In this chapter you find the explanation of the screen “Error code 105”

Screen	Cause	Actions
<p style="text-align: center;"><b>error 105 occurred</b></p> <p style="text-align: center;">Issue with the feeder trailer switches Wait until the machine is empty to be able to acknowledge this message</p> <p style="text-align: center;">Call the technician if needed (see next page)</p>	<p>error displayed if :</p> <p>trail in front position sensor and (middle or rear position) activated at the same time</p> <p>If program with feeder activated, stop feeder motion.</p> <p>Force clamp left and right opening</p>	<p>You can validate the error (Level 0 allowed) if machine is empty.</p> <p>Don't move the feeder trailer, and extend clamps to lateral position</p> <p>The program is stopped and go to program list</p> <p>Error reset can only be done via service task in service menu (level 1 minimum allowed)</p> <p>Only programs without Feeder will be authorized until the reset of this error.</p>

### 9.19 Error code 106 — Feeder trailer front switch

In this chapter you find the explanation of the screen "Error code 106"

Screen	Cause	Actions
<p style="text-align: center;"><b>error 106 occurred</b></p> <p style="text-align: center;">Issue with the feeder trailer front position switch Wait until the machine is empty to be able to acknowledge this message</p> <p style="text-align: center;">Call the technician if needed (see next page)</p>	<p>error displayed if :</p> <p>output "move the feeder to the front " is activated and after 5seconds the sensor "feeder in front position" is not activated</p> <p>If program with feeder activated, stop feeder motion.</p> <p>Force clamp left and right opening</p>	<p>You can validate the error (Level 0 allowed) if machine is empty.</p> <p>Don't move the feeder trailer, and extend clamps to lateral position</p> <p>The program is stopped and go to program list</p> <p>Error reset can only be done via service task in service menu (level 1 minimum allowed)</p> <p>Only programs without Feeder will be authorized until the reset of this error.</p>

### 9.20 Error code 107 — Feeder trailer middle switch

In this chapter you find the explanation of the screen "Error code 107"

Screen	Cause	Actions
<p style="text-align: center;"><b>error 107 occurred</b></p> <p style="text-align: center;">Issue with the feeder trailer middle position switch Wait until the machine is empty to be able to acknowledge this message</p> <p style="text-align: center;">Call the technician if needed (see next page)</p>	<p>error displayed if :</p> <p>starting from front position switch, when the trailer output "move to the rear is activated" and after 2 seconds the middle switch is not activated</p> <p>If program with feeder activated, stop feeder motion.</p> <p>Force clamp left and right opening</p>	<p>You can validate the error (Level 0 allowed) if machine is empty.</p> <p>Don't move the feeder trailer, and extend clamps to lateral position</p> <p>The program is stopped and go to program list</p> <p>Error reset can only be done via service task in service menu (level 1 minimum allowed)</p> <p>None programs will be authorized until the reset of this error.</p>

### 9.21 Error code 108 — Feeder trailer rear switch

In this chapter you find the explanation of the screen "Error code 108"

Screen	Cause	Actions
<p style="text-align: center;"><b>error 108 occurred</b></p> <p style="text-align: center;">Issue with the feeder trailer rear position switch Wait until the machine is empty to be able to acknowledge this message</p> <p style="text-align: center;">Call the technician if needed (see next page)</p>	<p>error displayed if :</p> <p>starting from front position switch, when the trailer output "move to the rear is activated" and after 4 seconds the rear switch is not activated</p> <p>If program with feeder activated, stop feeder motion.</p> <p>Force clamp left and right opening</p>	<p>You can validate the error (Level 0 allowed) if machine is empty.</p> <p>Move the feeder to the front, and extend clamps to lateral position</p> <p>The program is stopped and go to program list</p> <p>Error reset can only be done via service task in service menu (level 1 minimum allowed)</p> <p>None programs will be authorized until the reset of this error.</p>

### 9.22 Error code 109 — Dewrinckling sensor

In this chapter you find the explanation of the screen "Error code 109"

Screen	Cause	Actions
<p style="text-align: center;"><b>error 109 occurred</b></p> <p>Issue with the dewrinkling system. The function will be deactivated until servicing is done, Call the technician if needed (see next page)</p>	<p>error displayed if : dewrinkling sensor is activated for more than 5 minutes</p> <p>wrench icon activated and service task added to list of services</p>	<p>You can validate the error (Level 0 allowed) if machine is empty.</p> <p>The program is stopped and go to program list Error reset can only be done via service task in service menu (level 1 minimum allowed) if program selected with feeder and error active then display service popup</p>

### 9.23 Error code 200 — LF folding arm

In this chapter you find the explanation of the screen “Error code 200”

Screen	Cause	Actions
<p style="text-align: center;"><b>error 200 occurred</b></p> <p>Issue with the folding arm sensors, Remove the linen on the folding arm carefully and wait for the machine to be empty to be able to acknowledge this message Please call the technician (see next page)</p>	<p>error displayed if : front sensor and rear sensor of the folding arm are activated at the same time If program with feeder activated, stop feeder motion. Force clamp left and right opening length folding stop Cross and stacker continue</p>	<p>You can validate the error (Level 0 allowed) if machine is empty. The program is stopped and go to program list Error reset can only be done via service task in service menu (level 1 minimum allowed) None programs will be authorized until the reset of this error.</p> <p>Remove the linen on the folding arm carefully. Check the folding arm sensors</p>

### 9.24 Error code 201 — LF clutch

In this chapter you find the explanation of the screen “Error code 201”

Screen	Cause	Actions
<p style="text-align: center;"><b>error 201 occurred</b></p> <p>Issue with the clutch system or folding sensors, Remove the linen on the folding arm carefully and wait for the machine to be empty to be able to acknowledge this message Please call the technician (see next page)</p>	<p>error displayed if : no error 200 and if after clutch pulse and 500ms the sensor is still at the same status (meaning the arm didn't move or the sensor is in short circuit) If program with feeder activated, stop feeder motion. Force clamp left and right opening length folding stop Cross and stacker continue</p>	<p>You can validate the error (Level 0 allowed) if machine is empty. The program is stopped and go to program list Error reset can only be done via service task in service menu (level 1 minimum allowed) None programs will be authorized until the reset of this error.</p> <p>Remove the linen on the folding arm carefully. Check the folding arm sensors</p>

### 9.25 Error code 202 — Transfer

In this chapter you find the explanation of the screen “Error code 202”

Screen	Cause	Actions
<p style="text-align: center;"><b>error 202 occurred</b></p> <p>Issue with the transfer roller system Remove carefully all linens in the cross folder (rear casing), Then acknowledge this message, Please call the technician if needed (see next page)</p>	<p>error displayed if : if roller position down for more than 30 seconds AND rear cross table sensor =0 If program with feeder activated, stop feeder motion. Force clamp left and right opening length folding stop Cross folding stop Force transfer roller in up position</p>	<p>You can validate the error (Level 0 allowed) if machine is empty. The program is stopped and go to program list Error reset can only be done via service task in service menu (level 1 minimum allowed) None programs will be authorized until the reset of this error.</p>

### 9.26 Error code 300 — Air pressure

In this chapter you find the explanation of the screen “Error code 300”

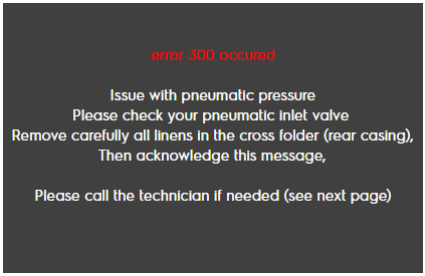
Screen	Cause	Actions
 <p>error 300 occurred</p> <p>Issue with pneumatic pressure Please check your pneumatic Inlet valve Remove carefully all linens in the cross folder (rear casing), Then acknowledge this message,</p> <p>Please call the technician if needed (see next page)</p>	<p>error displayed if : rear casing is closed AND pressure sensor status is 0 for more than 2 seconds</p> <p>If program with feeder activated, stop feeder motion. Force clamp left and right opening Length folding stop Cross folder stop</p>	<p>You can validate the error (Level 0 allowed) if machine is empty. The program is stopped and go to program list Error reset can only be done via service task in service menu (level 1 minimum allowed)</p> <p>Open rear casing, and remove the linen in the cross carefully. Close the rear casing. Check your compressed air inlet.</p>

### 9.27 Error code 301 — Cross 1 jam

In this chapter you find the explanation of the screen “Error code 301”

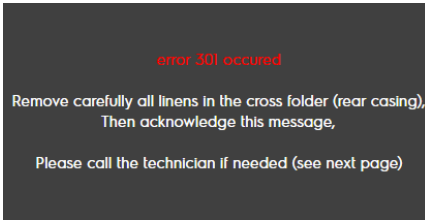
Screen	Cause	Actions
 <p>error 301 occurred</p> <p>Remove carefully all linens in the cross folder (rear casing), Then acknowledge this message,</p> <p>Please call the technician if needed (see next page)</p>	<p>Error displayed if : Linen jam in the first knife for the first transversal fold If program with feeder activated, stop feeder motion. Force clamp left and right opening Length folding stop Cross folder stop</p>	<p>You can validate the error (Level 0 allowed) if machine is empty. The program is stopped and go to program list Error reset can only be done via service task in service menu (level 1 minimum allowed)</p> <p>Open rear casing, and remove the linen in the cross carefully. Close the rear casing.</p>

### 9.28 Error code 302 — Cross 2/3 jam

In this chapter you find the explanation of the screen “Error code 302”

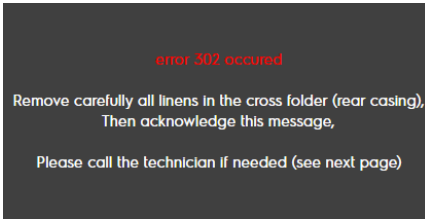
Screen	Cause	Actions
 <p>error 302 occurred</p> <p>Remove carefully all linens in the cross folder (rear casing), Then acknowledge this message,</p> <p>Please call the technician if needed (see next page)</p>	<p>Error displayed if : Linen jam in the second or third knife for the second or third transversal fold If program with feeder activated, stop feeder motion. Force clamp left and right opening Length folding stop Cross folder stop</p>	<p>You can validate the error (Level 0 allowed) if machine is empty. The program is stopped and go to program list Error reset can only be done via service task in service menu (level 1 minimum allowed)</p> <p>Open rear casing, and remove the linen in the cross carefully. Close the rear casing.</p>

### 9.29 Error code 303 — Cross exit jam

In this chapter you find the explanation of the screen “Error code 303”

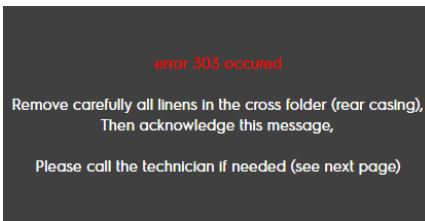
Screen	Cause	Actions
 <p>error 303 occurred</p> <p>Remove carefully all linens in the cross folder (rear casing), Then acknowledge this message,</p> <p>Please call the technician if needed (see next page)</p>	<p>Error displayed if : Linen blocked in the transfer table between cross folder system and stacker. If program with feeder activated, stop feeder motion. Force clamp left and right opening Length folding stop Cross folder stop Stacker stop</p>	<p>You can validate the error (Level 0 allowed) if machine is empty. The program is stopped and go to program list Error reset can only be done via service task in service menu (level 1 minimum allowed)</p> <p>Open rear casing, and remove the linen in the cross carefully. Close the rear casing.</p>

### 9.30 Error code 304 — Cross front left sensor

In this chapter you find the explanation of the screen “Error code 304”

Screen	Cause	Actions
<p style="text-align: center;"><b>error 304 occurred</b></p> <p style="text-align: center;">Issue with the cross table front left sensor Remove carefully all linens in the cross folder (rear casing), Then acknowledge this message,</p> <p style="text-align: center;">Please call the technician if needed (see next page)</p>	<p>Error displayed if :</p> <p>no linen in cross folder system and front left sensor activated for more than 20 seconds. If program with feeder activated, stop feeder motion. Force clamp left and right opening Length folding stop Cross folder stop</p>	<p>You can validate the error (Level 0 allowed) if machine is empty. The program is stopped and go to program list Error reset can only be done via service task in service menu (level 1 minimum allowed)</p> <p>Open rear casing, and check the left sensor.</p>

### 9.31 Error code 305 — Cross front right sensor

In this chapter you find the explanation of the screen “Error code 305”

Screen	Cause	Actions
<p style="text-align: center;"><b>error 305 occurred</b></p> <p style="text-align: center;">Issue with the cross table front right sensor Remove carefully all linens in the cross folder (rear casing), Then acknowledge this message,</p> <p style="text-align: center;">Please call the technician if needed (see next page)</p>	<p>Error displayed if :</p> <p>no linen in cross folder system and front right sensor activated for more than 20 seconds. If program with feeder activated, stop feeder motion. Force clamp left and right opening Length folding stop Cross folder stop</p>	<p>You can validate the error (Level 0 allowed) if machine is empty. The program is stopped and go to program list Error reset can only be done via service task in service menu (level 1 minimum allowed)</p> <p>Open rear casing, and check the sensor.</p>

### 9.32 Error code 306 — Cross middle right sensor

In this chapter you find the explanation of the screen “Error code 306”

Screen	Cause	Actions
<p style="text-align: center;"><b>error 306 occurred</b></p> <p style="text-align: center;">Issue with the cross table middle right sensor Remove carefully all linens in the cross folder (rear casing), Then acknowledge this message,</p> <p style="text-align: center;">Please call the technician if needed (see next page)</p>	<p>Error displayed if :</p> <p>no linen in cross folder system and table middle right sensor activated for more than 20 seconds. If program with feeder activated, stop feeder motion. Force clamp left and right opening Length folding stop Cross folder stop</p>	<p>You can validate the error (Level 0 allowed) if machine is empty. The program is stopped and go to program list Error reset can only be done via service task in service menu (level 1 minimum allowed)</p> <p>Open rear casing, and check the sensor.</p>

### 9.33 Error code 307 — Cross middle left sensor

In this chapter you find the explanation of the screen “Error code 307”

Screen	Cause	Actions
<p style="text-align: center;"><b>error 307 occurred</b></p> <p style="text-align: center;">Issue with the cross table middle left sensor Remove carefully all linens in the cross folder (rear casing), Then acknowledge this message,</p> <p style="text-align: center;">Please call the technician if needed (see next page)</p>	<p>Error displayed if :</p> <p>no linen in cross folder system and table middle left sensor activated for more than 20 seconds. If program with feeder activated, stop feeder motion. Force clamp left and right opening Length folding stop Cross folder stop</p>	<p>You can validate the error (Level 0 allowed) if machine is empty. The program is stopped and go to program list Error reset can only be done via service task in service menu (level 1 minimum allowed)</p> <p>Open rear casing, and check the sensor.</p>

### 9.34 Error code 308 — Cross rear left sensor

In this chapter you find the explanation of the screen “Error code 308”

Screen	Cause	Actions
<p style="text-align: center;"><b>error 308 occurred</b></p> <p style="text-align: center;">Issue with the cross table rear left sensor Remove carefully all linens in the cross folder (rear casing), Then acknowledge this message,</p> <p style="text-align: center;">Please call the technician if needed (see next page)</p>	<p>Error displayed if :</p> <p>no linen in cross folder system and rear left sensor activated for more than 20 seconds. If program with feeder activated, stop feeder motion. Force clamp left and right opening Length folding stop Cross folder stop</p>	<p>You can validate the error (Level 0 allowed) if machine is empty. The program is stopped and go to program list Error reset can only be done via service task in service menu (level 1 minimum allowed)</p> <p>Open rear casing, and check the sensor.</p>

### 9.35 Error code 310 — Rear panel sensor

In this chapter you find the explanation of the screen “Error code 310”

Screen	Cause	Actions
<p style="text-align: center;"><b>error 310 occurred</b></p> <p>The rear panel is open or there is an issue with the rear panel sensor, Please close the rear panel</p> <p style="text-align: center;">Or call the technician if needed (see next apge)</p>	<p>Error displayed if :</p> <p>no errors and rear panel is open. If program with feeder activated, stop feeder motion. Force clamp left and right opening Length folding stop Cross folder stop</p>	<p>You can validate the error (Level 0 allowed) if machine is empty. The program is stopped and go to program list Error reset can only be done via service task in service menu (level 1 minimum allowed)</p> <p>Open rear casing, and check the sensor of the rear panel..</p>

### 9.36 Error code 400 — Stacker height sensor

In this chapter you find the explanation of the screen “Error code 400”

Screen	Cause	Actions
<p style="text-align: center;"><b>error 400 occurred</b></p> <p>Issue with the stacker height sensor, Remove carefully all linens in the cross folder (rear casing), and in the stacker, Then, press the stacker button until buzzer (5sec), Then acknowledge this message, Call technician if needed (see next page)</p>	<p>Error displayed if :</p> <p>program with folding activated and stacker max height sensor is activated for more than 20sec If program with feeder activated, stop feeder motion. Force clamp left and right opening Length folding stop Cross folder stop Stacker stop</p>	<p>First : stacker button must be pressed during 5 sec, then buzzer to confirm (1sec) Then, you can validate the error (Level 0 allowed) if machine is empty. The program is stopped and go to program list Error reset can only be done via service task in service menu (level 1 minimum allowed)</p>

### 9.37 Error code 401 — Stacker entry sensor

In this chapter you find the explanation of the screen “Error code 401”

Screen	Cause	Actions
<p style="text-align: center;"><b>error 401 occurred</b></p> <p>Issue with the stacker entry sensor Remove carefully all linens in the cross folder (rear casing), and in the stacker, or check the alignment of the stacker</p> <p>Then press the stacker button until buzzer (5sec), Then acknowledge this message, Or call the technician if needed (see next page)</p>	<p>Error displayed if :</p> <p>stacker entry sensor activated for more than 20sec If program with feeder activated, stop feeder motion. Force clamp left and right opening Length folding stop Cross folder stop Stacker stop</p>	<p>First : stacker button must be pressed during 5 sec, then buzzer to confirm (1sec) Then, you can validate the error (Level 0 allowed) if machine is empty. The program is stopped and go to program list Error reset can only be done via service task in service menu (level 1 minimum allowed)</p>

### 9.38 Error code 402 — Stacker flaps sensor

In this chapter you find the explanation of the screen “Error code 402”

Screen	Cause	Actions
<p style="text-align: center;"><b>error 402 occurred</b></p> <p>Issue with the stacker flaps sensor Remove carefully all linens in the cross folder (rear casing), and in the stacker, Then press the stacker button until buzzer (5sec), Then acknowledge this message, Or call the technician if needed (see next page)</p>	<p>Error displayed if :</p> <p>if stacker flaps sensor is 0 for more than 5 seconds If program with feeder activated, stop feeder motion. Force clamp left and right opening Length folding stop Cross folder stop Stacker stop</p>	<p>First : stacker button must be pressed during 5 sec, then buzzer to confirm (1sec) Then, you can validate the error (Level 0 allowed) if machine is empty. The program is stopped and go to program list Error reset can only be done via service task in service menu (level 1 minimum allowed)</p> <p>Remove carefully all linens in the cross folder (remove rear casing) and in the stacker.</p>

### 9.39 Error code 403 — Stacker flaps opening motion

In this chapter you find the explanation of the screen “Error code 403”

Screen	Cause	Actions
<p style="text-align: center; color: red;">error 403 occurred</p> <p style="text-align: center;">Issue with the opening of the stacker flaps Remove carefully all linens in the cross folder (rear casing), and in the stacker,</p> <p style="text-align: center;">Then press the stacker button until buzzer (5sec), Then acknowledge this message,</p> <p style="text-align: center;">Or call the technician if needed (see next page)</p>	<p>Error displayed if :</p> <p>request to open the flaps and flaps sensor still = 1 after 1 second.</p> <p>If program with feeder activated, stop feeder motion.</p> <p>Force clamp left and right opening</p> <p>Length folding stop</p> <p>Cross folder stop</p> <p>Stacker stop</p>	<p>First : stacker button must be pressed during 5 seconds, then buzzer to confirm (1 second) Then, you can validate the error (Level 0 allowed) if machine is empty.</p> <p>The program is stopped and go to program list</p> <p>Error reset can only be done via service task in service menu (level 1 minimum allowed)</p> <p>Remove carefully all linens in the cross folder (remove rear casing) and in the stacker.</p>

### 9.40 Error code 404 — Stacker reset failure

In this chapter you find the explanation of the screen “Error code 404”

Screen	Cause	Actions
<p style="text-align: center; color: red;">error 404 occurred</p> <p style="text-align: center;">Stacker reset procedure has failed, From now all programs with folding will be disabled</p> <p style="text-align: center;">Please call the technician (see next page)</p>	<p>Error displayed if :</p> <p>if error 400 OR 401 OR 402 or 403 AND stacker reset failed = 1</p> <p>If program with feeder activated, stop feeder motion.</p> <p>Force clamp left and right opening</p> <p>Length folding stop</p> <p>Cross folder stop</p> <p>Stacker stop</p>	<p>You can validate the error (Level 0 allowed) if machine is empty.</p> <p>The program is stopped and go to program list</p> <p>Error reset can only be done via service task in service menu (level 1 minimum allowed)</p> <p>Remove carefully all linens in the cross folder (remove rear casing) and in the stacker.</p>

## 10 Maintenance



### Caution



Disconnect the power supply and leave the ironing bed to cool down prior to any repair work or servicing. To get the best results and optimum safety from your machine, observe all the servicing instructions.



### Caution



This chapter describe only the maintenance program realised by the operator without opening casing. For the complete maintenance program, please upload service manual on our website.

### 10.1 Preventive maintenance



### Caution



To ensure that your machine gives the very best service, please take care that maintenance is carried strict accordance with the instructions above mentioned. Execute these instructions at regular intervals and according to the frequency of use.

#### Each day (at the beginning of each working day)

- **1** Check that the emergency stop button works correctly.
- **2** Check that the machine stops when you press the mobile finger protector.

#### Every week (40h)

- **3** Clean the drive system of the dewrinkling strips outside the machine.
- **4** Clean motor ventilation grills of cross folding system.
- **5** Clean the separators accessible on the front of the machine.
- **6** Clean the detection cells and the reflectors. (feeding system, dewrinkling system, and cross folding system)
- **7** Check and clean the fluff filter (on gas heating only). Clean the box of the filter with suction device.
- **8** Remove dust from outside the machine.

#### Every month (170h)

- **16** Check operation of the handle (see next chapter).

#### Every 6 months (1000h)

- **21** Check the condition of ironing belts and their staples.
- **22** Check the feed belts and their drive and ejection bands.
- **33** Check the other belts (stacker,...)

#### Every year (2000h)

- **25** Clean external pipes done by customer.



### Caution



The dryer-ironing machine textile components must be considered as wearing parts. The lifetime of these parts (ironing strips, feeding strips, clamping belts, transfer belts, etc...) is highly dependent on the usage conditions and maintenance frequencies. Consequently, their replacement may not be claimed under any guarantee.

#### Motors

- The fan motor is life lubricated.
- The movement reduction gear is life lubricated.



### Cylinder

- The cylinder must be maintained very carefully so that ironing is easy and good quality.
- Detergent or scale deposits must be removed as soon as they reduce ironing quality (jamming, creases on the washing, etc ...).

### 10.2 Using the handle

The dryer ironer is fitted with a handle.

This is very useful to take out the linen if there is a power failure while you are ironing; or you can use it to feed a piece of wet washing to protect the ironing bands when the ironing temperature is too high.

Lift the safety plate (1)

Then push the handle to connect it to the movement motor (2).

And turn the handle in the clockwise direction (3) to rotate the cylinder and take out the linen.

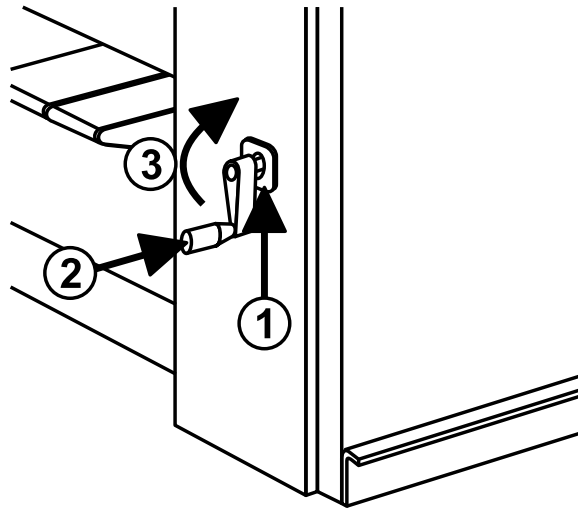

## 11 Technical characteristics

A : Front View

B : Left View

C : Top View

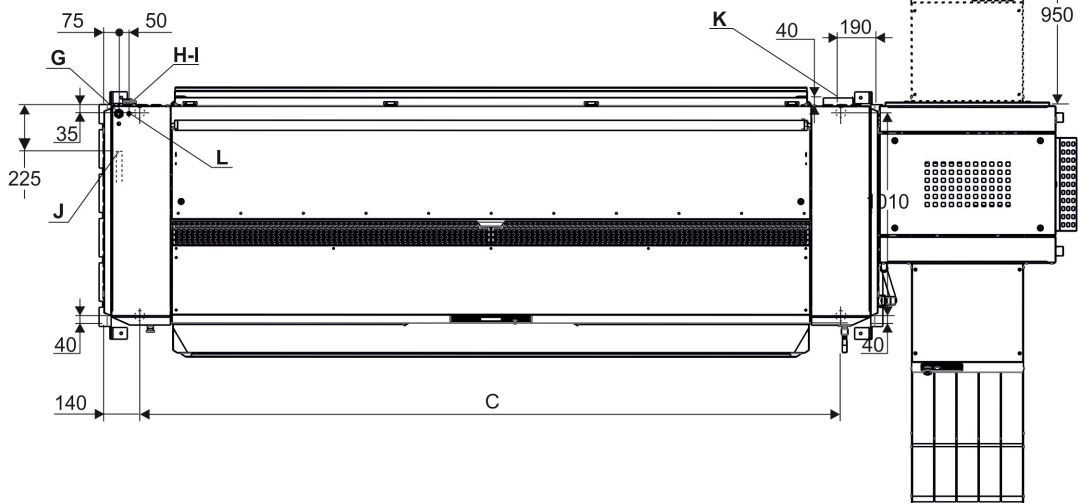
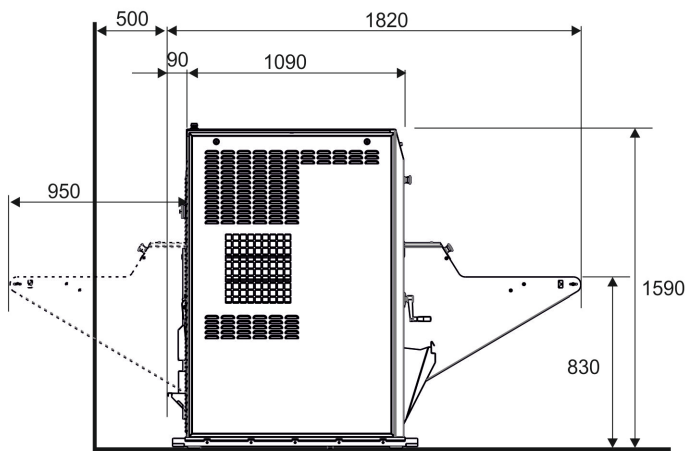
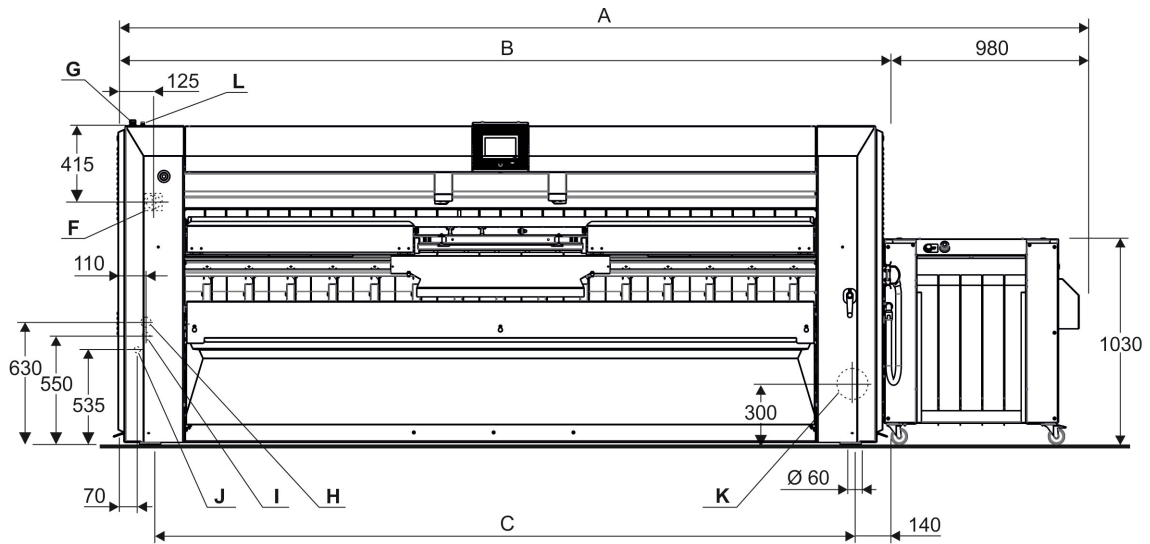

Characteristics / type machine		Units	4821	4825	4832
<b>A</b>	Overall width	mm	3780	4185	4815
<b>B</b>	Ironer width	mm	2800	3205	3835
<b>C</b>	Width between feet	mm	2620	2925	3555
	Cylinder diameter Gas / Electric heating	mm	479	479	479
	Cylinder diameter Steam heating	mm	457	457	457
	Effective working width	mm	2120	2540	3170
	Ironer Floor area	m <sup>2</sup>	2.6	3.78	4.52
	Stacker Floor area	m <sup>2</sup>	1.78	1.78	1.78
	Ironer net weight Gas heating / Dubixium cylinder	kg	1440	1545	1715
	Ironer net weight Electric heating / Dubixium cylinder	kg	1440	1545	1715
	Ironer net weight Steam heating	kg	1520	1650	1830
	Stacker net weight	kg	175	175	175
	Ironing speed mini	m/min	1.5	1.5	1.5
	Ironing speed maxi	m/min	11	11	11
	Heating surface Gas / Electric heating	m <sup>2</sup>	2.2	2.9	3.6
	Heating surface Steam heating	m <sup>2</sup>	2.1	2.7	3.4
<b>Connections</b>					
<b>F</b>	Main switch to connect electric main cable				
<b>G</b>	Inlet for electric main cable				
<b>H</b>	Steam inlet	mm	20 (3/4")	20 (3/4")	20 (3/4")
	Maximum supply pressure	kPa	1000	1000	1000
<b>I</b>	Condensate return	mm	10 (3/8")	10 (3/8")	10 (3/8")
<b>J</b>	Gas Inlet	mm(")	20 (3/4")	20 (3/4")	20 (3/4")
<b>K</b>	Drain of vapour or burnt gas	∅ mm	150	150	150
	Exhaust air max. with no pressure at 15°C Gas heating	m <sup>3</sup> /h	830	950	1010
	Exhaust air max. with no pressure at 15°C Electrical & Steam heating	m <sup>3</sup> /h	740	880	960
	Total pressure with no flow	Pa	880	880	880
	Admissible pressure drop on evacuation	Pa	200	200	200
<b>L</b>	Air inlet	∅ mm	6/8	6/8	6/8
	Air pressure , mini-maxi	bar	5.5–7	5.5–7	5.5–7
	Consumption	l/h	280	280	280
<b>Consumptions</b>					
<b>Gas heating / Dubixium cylinder</b>					
	Installed electric power	kW	2.9	2.9	3.2
	Installed heating power	kW	44	52	65
	Maximum electrical consumption	kWh	2.7	2.7	3
	Max. water evaporation capacity With 50 % residual moisture content and 100 % cylinder utilization (according to ISO 93.98 standard).	kg/h	37	46	59
<b>Electric heating / Dubixium cylinder</b>					
	Installed electric power	kW	37.7	46.10	56.75
	Installed heating power	kW	37.2	43.20	53.55
	Maximum electrical consumption	kWh	36.45	44.25	54.48

---

Max. water evaporation capacity With 50 % residual moisture content and 100 % cylinder utilization (according to ISO 93.98 standard).	kg/h	40	48	59
---	------	----	----	----

**Steam heating**

Installed electric power	kW	2.9	2.9	3.2
Maximum electrical consumption	kWh	2.7	2.7	3
Maximum steam consumption at 900 kPa	kg/h	92	110	141
Inner volume steam cylinder	dm <sup>3</sup>	335	398	497
Max. water evaporation capacity With 50 % residual moisture content and 100 % cylinder utilization (according to ISO 93.98 standard).	kg/h	63	75	93

Heat loss (3% of installed heating power)

---

## 12 Conversion of measurement units

This following is a list of correspondences of the main frequency used units, to avoid the need to use measurement unit conversion table.

<b>bar</b>	1 bar = 100 000 Pa 1 bar = 1.019 7 kg/cm <sup>2</sup> 1 bar = 750.06 mm Hg 1 bar = 10 197 mm H <sub>2</sub> O 1 bar = 14.504 psi	<b>British thermal unit</b>	1 Btu = 1 055.06 J 1 Btu = 0.2521 kcal
<b>calorie</b>	1 cal = 4.185 5 J 1 cal = 10 <sup>-6</sup> th 1 kcal = 3.967 Btu 1 cal/h = 0.001 163 W 1 kcal/h = 1.163 W	<b>Continental horse power</b>	1 ch = 0.735 5 kW 1 ch = 0.987 0 HP
<b>cubic foot</b>	1 cu ft = 28 316 8 dm <sup>3</sup> 1 cu ft = 1 728 cu in	<b>cubic inch</b>	1 cu in = 16.387 1 dm <sup>3</sup>
<b>foot</b>	1 ft = 304.8 mm 1 ft = 12 in	<b>gallon (U.K.)</b>	1 gal = 4.545 96 dm <sup>3</sup> or l 1 gal = 277.41 cu in
<b>gallon (U.S.A.)</b>	1 gal = 3.785 33 dm <sup>3</sup> or l 1 gal = 231 cu in	<b>horse power</b>	1 HP = 0.745 7 kW 1 HP = 1.013 9 ch
<b>inch</b>	1 in = 25.4 mm	<b>joule</b>	1 J = 0.000 277 8 Wh 1 J = 0.238 92 cal
<b>kilogramme</b>	1 kg = 2.205 62 lb	<b>kg/cm<sup>2</sup></b>	1 kg/cm <sup>2</sup> = 98 066.5 Pa 1 kg/cm <sup>2</sup> = 0.980 665 bar 1 kg/cm <sup>2</sup> = 10 000 mm H <sub>2</sub> O 1 kg/cm <sup>2</sup> = 735.557 6 mm Hg
<b>pound</b>	1 lb = 453.592 37 g	<b>meter</b>	1 m = 1.093 61 yd 1 m = 3.280 83 ft 1 m = 39.37 in
<b>cubic meter</b>	1 m <sup>3</sup> = 1 000 dm <sup>3</sup> 1 m <sup>3</sup> = 35.214 7 cu ft 1 dm <sup>3</sup> = 61.024 cu in 1 dm <sup>3</sup> = 0.035 3 cu ft	<b>pascal</b>	1 Pa = 1 N/m <sup>2</sup> 1 Pa = 0.007 500 6 mm Hg 1 Pa = 0.101 97 mm H <sub>2</sub> O 1 Pa = 0.010 197 g/cm <sup>2</sup> 1 Pa = 0.000 145 psi 1 MPa = 10 bar
<b>psi</b>	1 psi = 0.068947 6 bar	<b>thermie</b>	1 th = 1 000 kcal 1 th = 10 <sup>+6</sup> cal 1 th = 4.185 5 x 10 <sup>+6</sup> J 1 th = 1.162 6 kWh 1 th = 3 967 Btu
<b>watt</b>	1 W = 1 J/s 1 W = 0.860 11 kcal/h	<b>watt-hour</b>	1 Wh = 3 600 J 1 kWh = 860 kcal
<b>yard</b>	1 yd = 0.914 4 m 1 yd = 3 ft 1 yd = 36 in	<b>temperature degrees</b>	0 °K = -273.16 °C 0 °C = 273.16 °K t °C = 5/9 (t °F-32) t °F = 1.8 t °C + 32















## 13 Explanation of washing symbols

(ISO 3758:2005 standard)

To overcome language barriers, the following are symbols used internationally to give you guidance and recommendations when washing different textiles.



### 13.1 Washing

The tub symbolizes washing.

Symbols	Max. washing temperature in °C	Mechanical action
	95	normal
	95	mild
	70	normal
	60	normal
	60	mild
	50	normal
	50	mild
	40	normal
	40	mild
	40	very mild
	30	normal
	30	mild
	30	very mild
	40	wash by hand
	-	do not wash



### 13.2 Bleaching

The triangle symbolizes bleaching.

Symbols	Explanation
	Bleaching allowed (chlorine or oxygen).
	Bleaching allowed (only oxygen).
	Do not bleach.





### 13.3 Drying

The circle in a square symbolizes tumble drying.

Symbols	Explanation
	Can be put in a tumble dryer. Normal temperature.
	Can be put in a tumble dryer. Lower temperature.
	Do not put in a tumble dryer.



### 13.4 Ironing

The iron symbolizes the domestic ironing and pressing process.





Symbols	Explanation
	Max. temperature 200 °C.
	Max. temperature 150 °C.
	Max. temperature 110 °C. The steam can cause irreversible damages.
	Do not iron.

### 13.5 Dry or water cleaning

The circle symbolizes dry or water cleaning.

Symbols	Explanation
	Normal dry cleaning with perchloroethyl, solvent of hydrocarb.
	Mild dry cleaning with perchloroethyl, solvent of hydrocarb.
	Normal dry cleaning with solvent of hydrocarbon.

---

	Mild dry cleaning with solvent of hydrocarbon.
	Do not dry clean.
	Normal water cleaning.
	Mild water cleaning.
	Very mild water cleaning.







Electrolux Professional AB  
341 80 Ljungby, Sweden  
[www.electroluxprofessional.com](http://www.electroluxprofessional.com)